

Dell™ Inspiron™ 5000e System

SOLUTIONS GUIDE

www.dell.com
support.dell.com



Hints, Notices, and Cautions



HINT: A HINT indicates important information that helps you make better use of your computer.



NOTICE: A NOTICE indicates either potential damage to hardware or loss of data and tells you how to avoid the problem.



CAUTION: A CAUTION indicates a potentially hazardous situation which, if not avoided, may result in minor or moderate injury.

Abbreviations and Acronyms

For a complete listing of abbreviations and acronyms, see the Glossary in the *Tell Me How* help file (see the *Start Here* sheet for instructions on how to open the help file).

Information in this document is subject to change without notice.
© 2000 Dell Computer Corporation. All rights reserved.

Reproduction in any manner whatsoever without the written permission of Dell Computer Corporation is strictly forbidden.

Trademarks used in this text: *Dell*, the *DELL E COM* logo, *Dellnet*, *Inspiron*, and *DellWare* are trademarks of Dell Computer Corporation; *Intel* is a registered trademark of Intel Corporation; *Microsoft* and *Windows* are registered trademarks of Microsoft Corporation.

Other trademarks and trade names may be used in this document to refer to either the entities claiming the marks and names or their products. Dell Computer Corporation disclaims any proprietary interest in trademarks and trade names other than its own.

August 2000 P/N 91XWT Rev. A00

Safety Instructions

Use the following safety guidelines to help protect yourself and your computer. For comfort and efficiency, observe the ergonomic guidelines in "Sitting Comfortably at Your Computer" in the *Tell Me How* help file.

When Using Your Computer

- Do not attempt to service the computer yourself. Always follow installation instructions closely.
- Do not carry a battery pack in your pocket, purse, or other container where metal objects (such as car keys) could short-circuit the battery terminals. The resulting excessive current flow can cause extremely high temperatures and may result in damage from burns.
- Be sure that nothing rests on your AC adapter's power cable and that the cable is not located where it can be tripped over or stepped on.
- Place the AC adapter in a ventilated area, such as a desk top or on the floor, when you use it to run the computer or to charge the battery. Do not cover the AC adapter with papers or other items that will reduce cooling; also, do not use the AC adapter inside a carrying case.
- Do not use your computer in a wet environment, for example, near a bath tub, sink, or swimming pool or in a wet basement.
- Do not push objects into air vents or openings of your computer. Doing so can cause fire or electric shock by shorting out interior components.
- Use only the AC adapter and batteries that are approved for use with this computer as indicated in this document. Use of another type of battery pack or AC adapter may risk fire or explosion.
- Before you connect the computer to a power source, ensure that the voltage rating of the AC adapter matches that of the available power source:
 - 115 volts (V)/60 hertz (Hz) in most of North and South America and some Far Eastern countries such as South Korea and Taiwan
 - 100 V/50 Hz in eastern Japan and 100 V/60 Hz in western Japan
 - 230 V/50 Hz in most of Europe, the Middle East, and the Far East

- To help prevent electric shock, plug the AC adapter and peripheral power cables into properly grounded power sources. These cables are equipped with 3-prong plugs to help ensure proper grounding. Do not use adapter plugs or remove the grounding prong from a cable. If you must use an extension cable, use a 3-wire cable with properly grounded plugs.
- If you use an extension cable with your AC adapter, ensure that the total ampere rating of the products plugged in to the extension cable does not exceed the ampere rating of the extension cable.
- To remove power from the computer, turn it off, remove the battery pack, and disconnect the AC adapter from the electrical outlet.
- If your computer includes an integrated or optional (PC Card) modem, disconnect the modem cable during an electrical storm to avoid the remote risk of electric shock from lightning via the telephone line.
- To help avoid the potential hazard of electric shock, do not connect or disconnect any cables or perform maintenance or reconfiguration of this product during an electrical storm.
- PC Cards may become very warm during normal operation. Use care when removing PC Cards after their continuous operation.
- Do not dispose of battery packs in a fire. They may explode. Check with local authorities for disposal instructions.
- When setting up the computer for work, place it on a level surface.
- When traveling, do not check the computer as baggage. You can put your computer through an X-ray security machine, but *never* put your computer through a metal detector. If you have the computer checked by hand, be sure to have a charged battery available in case you are asked to turn on the computer.
- When traveling with the hard-disk drive removed from the computer, wrap the drive in a nonconducting material, such as cloth or paper. If you have the drive checked by hand, be ready to install the drive in the computer. You can put the hard-disk drive through an X-ray security machine, but *never* put the drive through a metal detector.
- When traveling, do not place the computer in overhead storage compartments where it could slide around. Do not drop your computer or subject it to other mechanical shocks.

- Protect your computer, battery, and hard-disk drive from environmental hazards such as dirt, dust, food, liquids, temperature extremes, and overexposure to sunlight.
- When you move your computer between environments with very different temperature and/or humidity ranges, condensation may form on or within the computer. To avoid damaging the computer, allow sufficient time for the moisture to evaporate before using the computer.



NOTICE: When taking the computer from low-temperature conditions into a warmer environment or from high-temperature conditions into a cooler environment, allow the computer to acclimate to room temperature before turning on power.

- When you disconnect a cable, pull on its connector or on its strain-relief loop, not on the cable itself. As you pull out the connector, keep it evenly aligned to avoid bending any connector pins. Also, before you connect a cable make sure both connectors are correctly oriented and aligned.
- Handle components with care. Hold a component such as a memory module by its edges, not its pins.
- When removing a memory module from the system board or disconnecting a peripheral device from the computer, wait 5 seconds after turning off the computer before removing the memory module or disconnecting the device to help avoid possible damage to the system board.
- Before you clean your computer, turn it off, unplug it from its power source, and remove the battery pack(s).
- Clean your computer with a soft cloth dampened with water rather than with liquid or aerosol cleaners.
- Clean the display with a soft, clean cloth and commercial window cleaner that does not contain wax or abrasives. Apply the cleaner to the cloth; then stroke the cloth across the display in one direction, moving from the top of the display to the bottom. If the display contains grease or some other contaminant, use isopropyl alcohol instead of commercial window cleaner.
- If your computer gets wet, see page 42 for instructions. If you drop or damage the computer, see page 43. If, after following these procedures, you confirm that your computer is not operating properly, contact Dell (see page 76).

When Removing or Installing Memory Modules

Before you remove or install memory modules, perform the following steps in the sequence indicated.



NOTICE: The only time you should ever access the inside of your computer is when you are installing memory modules.



NOTICE: Wait 5 seconds after turning off the computer before disconnecting a peripheral device or removing a memory module to help prevent possible damage to the system board.

- 1 Turn off your computer and all attached devices.
- 2 Disconnect your computer and peripheral devices from their electrical outlets to reduce the potential for personal injury or shock. Also, disconnect any telephone or telecommunication lines from the computer.
- 3 Remove the battery from the battery bay and, if present, the secondary battery from the modular bay.
- 4 Ground yourself by touching an unpainted metal surface at the back of the computer before touching anything inside your computer.

While you work, periodically touch an unpainted metal surface on the computer to dissipate any static electricity that might harm internal components.

In addition, take note of these safety guidelines when appropriate:

- When you disconnect a cable, pull on its connector, not on the cable itself. As you pull connectors apart, keep them evenly aligned to avoid bending any pins. Also, before you connect a cable, make sure that both connectors are correctly oriented and aligned.
- Handle memory modules with care. Don't touch the components on a module. Hold a module by its edges.



CAUTION: There is a danger of a new battery exploding if it is incorrectly installed. Replace the battery only with the same or equivalent type recommended by the manufacturer. Discard used batteries according to the manufacturer's instructions.

Protecting Against Electrostatic Discharge

To prevent static damage, discharge static electricity from your body before you touch anything inside your computer and periodically while you work inside the computer. You can do so by touching an unpainted metal surface on the back of the computer.

You can also take the following steps to prevent static damage:

- Do not remove items from their antistatic packing material until you are ready to install them in your computer. Just before unwrapping the antistatic packaging, be sure to discharge static electricity from your body.
- When transporting a sensitive component, first place it in an antistatic container or packaging.

Contents

1 Setting Up

Setting Up Dellnet™	16
Accessing the Internet	16
Accessing Your E-Mail	16
Viewing Your Account Information	16
Sending and Receiving E-Mail	17
Resetting E-Mail Address Settings	17
Connecting a Printer	18
Parallel Printer	18
USB Printer	19
Installing the Printer Driver	20
Turning Off the Computer	20
Windows Millennium Edition (Me)	21
Windows 98	21
Windows 2000	21
Setting Up the APR to Connect to a Network	22
Setting Up the APR for Windows Me and Windows 98	22
Setting Up the APR for Windows 2000	23

2 Solving Problems

Finding Solutions	27
Power Problems	29
Start-Up Error Messages	30
Video and Display Problems	30

If the display is blank	30
If the display is difficult to read	30
Sound and Speaker Problems	31
Integrated Speakers	31
External Speakers	32
Printer Problems	33
If you cannot print to a parallel port printer	33
If you cannot print to a USB printer	33
Modem Problems	34
Scanner Problems	35
Touch Pad Problems	36
External Keyboard Problems	36
Unexpected Characters	36
Drive Problems	36
If you cannot save a file to a floppy disk	36
If you cannot play a music CD or install a program from a CD	37
If you cannot play a DVD movie	38
If the CD-RW drive stops writing	38
If you have a hard drive problem	38
Network Problems	39
Windows Error Messages	39
General Program Problems	40
A program crashes	40
A program stops responding	40
A solid blue screen appears	41
Internet Connection Problems	41
If you have a problem with your Dellnet account	41
E-Mail Problems	42

If Your Computer Gets Wet	42
If You Drop or Damage Your Computer	43
Resolving Other Technical Problems	44
Reinstalling Drivers and Utilities	44
Reinstalling Windows	45
Reinstalling Windows Me and Windows 98	45
Reinstalling Windows 2000	46
Recreating the Hibernate File (Windows 98 Only)	47
Boot (Restart) Your Computer With the System Software CD	48
Delete the Old Hibernate File	48
Create the Hibernate File	49
Enable Hibernate Support	49

3 Adding Parts

Using the Modular Bay	52
Swapping Devices While the Computer Is Turned Off	52
Swapping Devices While the Computer Is Turned On	53
Installing a Battery	54
Installing a Second Battery in the Modular Bay	55
PC Cards	56
Installation	56
Removal	56
Docking the Computer	56
Connecting to a Port Replicator	56
Detaching (Undocking) From a Port Replicator	58
Connecting External Devices to a Port Replicator	58
Connectors on a Port Replicator	59
Buttons and Indicators	61
Adding Memory	62

Replacing a Hard Drive	64
Returning a Hard Drive to Dell	66

4 Appendix

Specifications	68
Standard Settings	74
System Setup Screens	74
Contacting Dell	76
Contact Numbers and Addresses	76
Returning Items for Warranty Repair or Credit	85
Regulatory Information	86
Battery Disposal	86
NOM Information (Mexico Only)	87
Información para NOM (únicamente para México)	87
Warranty and Return Policy Information	88

SECTION 1

Setting Up

Setting Up Dellnet™

Connecting a Printer

Turning Off the Computer

Setting Up the APR to Connect to a Network

 **HINT:** Dellnet is not available in certain regions.



Setting Up Dellnet™

To set up Dellnet Internet Access Service, double-click the **Dellnet Signup** icon on the Microsoft® Windows® desktop and follow the instructions that appear on the screen.

Accessing the Internet



To access the Internet after completing the Dellnet registration process, double-click the **Internet Explorer** icon on your Windows desktop. Internet Explorer automatically initiates the Internet connection through Dellnet.

Accessing Your E-Mail



To access your Dellnet e-mail, double-click the **Outlook Express** icon on your Windows desktop. Click **Send/Receive** to download your messages from the mail server. When you download your messages, they are stored on your hard drive until you delete them.

 **HINT:** Dellnet allows you to use case-sensitive passwords. Be sure that <Caps Lock> is not turned on.

Viewing Your Account Information

If you did not record your Dellnet user name or password, access the **Dellnet Administration** tool to verify or change this information:

- 1 Click the **Start** button, point to **Programs—>Dellnet**, and then click **Dellnet Administration**.
- 2 Click **Next** twice.
- 3 Click **Connect** to connect to Dellnet.
- 4 When the **Dellnet Self-Administration** page appears, click **View My Account Information**.
- 5 Click **Next**.
- 6 Type your **Challenge Question** answer.
- 7 Click **Next**.

Your account information appears on the screen.

- 8 Click **Print** to print the information or click **Main Menu** to go to the main menu.

Sending and Receiving E-Mail

- Double-click the **Outlook Express** icon to initiate a connection to the Internet through Dellnet.
- Always check the address of each recipient when sending e-mail. Otherwise, your e-mail is returned to you.
- Be sure that the person who is sending e-mail to you is typing your e-mail address correctly.
- Do not send e-mail messages larger than 2 MB.
- If you are having difficulties sending e-mail, determine whether the problem involves just one recipient or all recipients. Then contact the Dellnet technical support staff (see page 76).



Resetting E-Mail Address Settings

If your e-mail software gets corrupted, reset your account:

- 1 Click the **Start** button, point to **Programs**—>**Dellnet**, and then click **Dellnet Administration**.
- 2 Click **Next** twice.
- 3 Click **Connect** to connect to Dellnet.
- 4 When the **Dellnet Self-Administration** page appears, click **Make My Changes Take Effect**.
- 5 Click **Next**.
- 6 Enter your **Challenge Phrase** answer.
- 7 Click **Next**.
- 8 Click the **Click To Make Changes Take Effect** button.
- 9 Click **OK**.



Connecting a Printer

See the documentation that came with the printer for any recommended preparation procedures, such as:

- Removing the packaging
- Installing the toner or ink cartridge
- Loading paper

Then follow the instructions that came with the printer to connect it to the computer. If no information is provided, see the following sections.

Parallel Printer

- 1 Turn off the computer (see page 20).



NOTICE: Use only a standard IEEE parallel cable measuring 3 m (10 ft) or less to connect the printer to the computer. Use of a nonstandard cable may prevent the printer from working.

- 2 Attach the parallel printer cable to the parallel port connector on the computer and tighten the two screws. Attach the cable to the parallel connector on the printer and snap the two clips into the two notches.

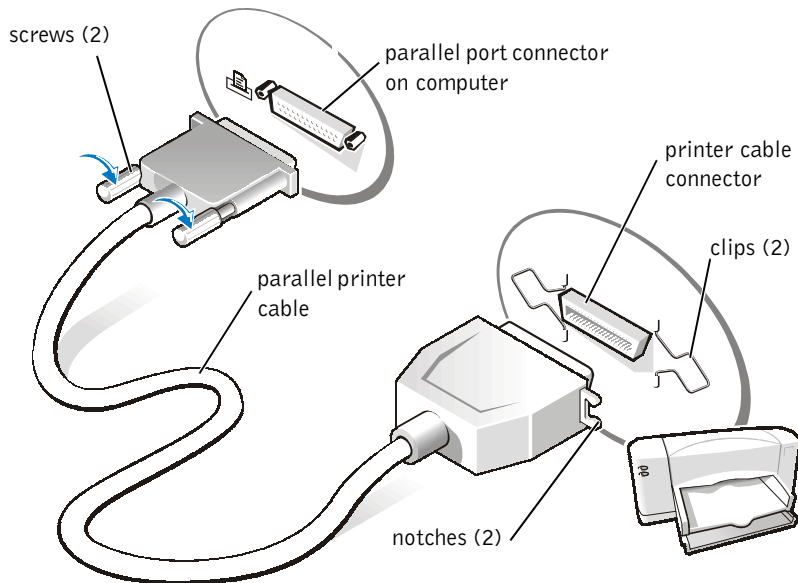

- 3 Turn on the printer and then turn on the computer. If the Add New Hardware Wizard window appears, click **Cancel**.
- 4 Install the printer driver if necessary (see page 20).

USB Printer

- 1 Install the printer driver if necessary (see page 20).

 **HINT:** You can connect USB devices while the computer is turned on.

- 2 Attach the USB printer cable to the USB port connector on the computer and the printer. The USB connectors fit only one way.

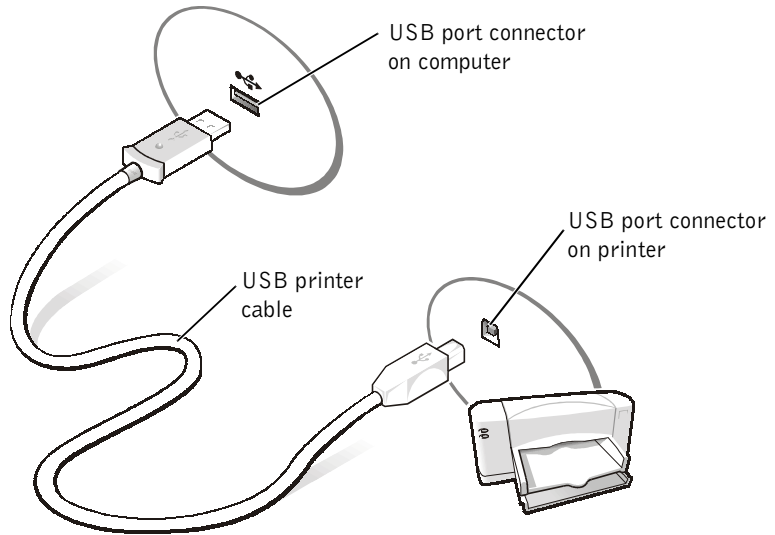

HINT: Dell installs drivers for some new printers. Click the **Start** button, point to **Settings**, and then click **Printers**. If your printer is listed in the **Printers** window, the printer is ready to use.

Installing the Printer Driver

If you need to install a printer driver, insert the installation CD into the CD or DVD drive. Then follow the prompts on the screen using the instructions that came with the printer.

If your printer installation CD does not automatically run, click the **Start** button on the Windows desktop, click **Run**, and type `x:\setup.exe` (where `x` is the letter of your CD or DVD drive [usually drive D]). Then click **OK** and follow the prompts on your screen.

Turning Off the Computer



NOTICE: To prevent data loss, you must perform the Windows shutdown procedure to turn off your computer.

Windows Millennium Edition (Me)

- 1 Save and close any open files and exit any open programs.
- 2 Click the **Start** button, and then click **Shut Down**.
- 3 Click the pull-down menu under **What do you want the computer to do?**
- 4 Click **Shut down** and then click **OK**.

The computer automatically turns off after the shutdown process finishes.

Windows 98

- 1 Save and close any open files and exit any open programs.
- 2 Click the **Start** button, and then click **Shut Down**.
- 3 In the **Shut Down Windows** window, click **Shut down** and then click **OK**.

The computer automatically turns off after the shutdown process finishes.

Windows 2000

- 1 Save and close any open files and exit any open programs.
- 2 Click the **Start** button, and then click **Shut Down**.
- 3 Click the pull-down menu under **What do you want the computer to do?**
- 4 Click **Shut down** and then click **OK**.

The computer automatically turns off after the shutdown process finishes.

 **HINT:** A network adapter is also referred to as a network interface controller (NIC).

Setting Up the APR to Connect to a Network

If you purchased the advanced port replicator (APR) with an integrated network adapter, you must first configure the computer to use the APR with a network.

Setting Up the APR for Windows Me and Windows 98

- 1 If the computer is on, shut down the operating system and turn off the computer (see page 20).
- 2 Disconnect all external devices from the APR.
- 3 Insert the computer into the APR.
- 4 Turn on the computer.
- 5 The computer automatically detects the network adapter and begins the software installation.
- 6 At the **This wizard searches for new drivers for: Intel 8255x-based PCI Ethernet Adapter (10/100)** dialog box, click **Next**.
- 7 At the **What do you want Windows to do?** dialog box, click **Search for the best driver for your device (Recommended)**, and then click **Next**.
- 8 Insert the *Inspiron 5000 Advanced Port Replicator* CD into the CD or DVD drive.
- 9 When asked for the location of the driver, deselect **Floppy disk drives**.
- 10 Click **Specify a location**:
- 11 Type `x:\w98_nic` (where *x* is the drive letter of your CD or DVD drive), and then click **Next**.
- 12 At the **What do you want to install?** dialog box, click **The updated driver (Recommended) - Actiontec 82559-based Mini PCI Adapter (10/100)**, and then click **Next**.
- 13 When Windows displays the message that it is ready to install the driver from `x:\w98_nic\net82557.inf` (where *x* is the letter of your CD or DVD drive), click **Next**.
- 14 Click **Finish** when Windows displays a message that the driver is installed.

- 15 Click **Yes** to restart the computer.
- 16 After the computer restarts, Windows modifies settings, creates a **Dock** I configuration, and then displays a **Setup is complete** message.
- 17 Click **OK**.
- 18 If the **Updated display settings** message appears, click **OK**.
- 19 If necessary, consult your network administrator for instructions on configuring the network adapter settings.

Setting Up the APR for Windows 2000

 **NOTICE:** Do not install the drivers from the CD that is shipped with the APR. The network adapter will not work if they are installed.

- 1 If the computer is on, shut down the operating system and turn off the computer (see page 20).
- 2 Disconnect all external devices from the APR.
- 3 Insert the computer into the APR.
- 4 Attach the network cable and the power adapter to the APR.
- 5 Turn on the computer.
- 6 Log on as **Administrator**.
- 7 Make sure that **Intel 8255x-based PCI Ethernet Adapter (10/100)** appears in the **Found New Hardware** window.

Windows 2000 automatically installs the network adapter drivers.

SECTION 2

Solving Problems

Finding Solutions
Power Problems
Start-Up Error Messages
Video and Display Problems
Sound and Speaker Problems
Printer Problems
Modem Problems
Scanner Problems
Touch Pad Problems
External Keyboard Problems
Unexpected Characters
Drive Problems
Network Problems
Windows Error Messages
General Program Problems
Internet Connection Problems
E-Mail Problems
If Your Computer Gets Wet
If You Drop or Damage Your Computer

Resolving Other Technical Problems

Reinstalling Drivers and Utilities

Reinstalling Windows

Recreating the Hibernate File (Windows 98 Only)

Finding Solutions

Sometimes it's difficult to figure out where to go for answers. Use this chart to help you quickly find the answers to your questions.

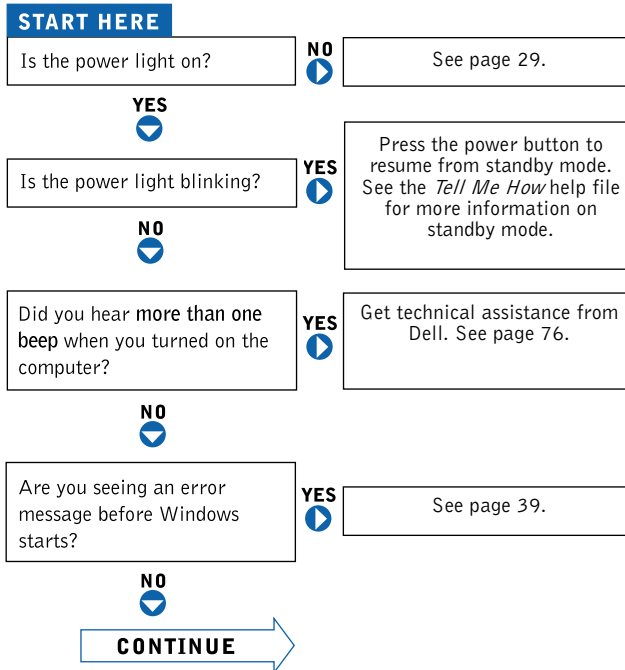

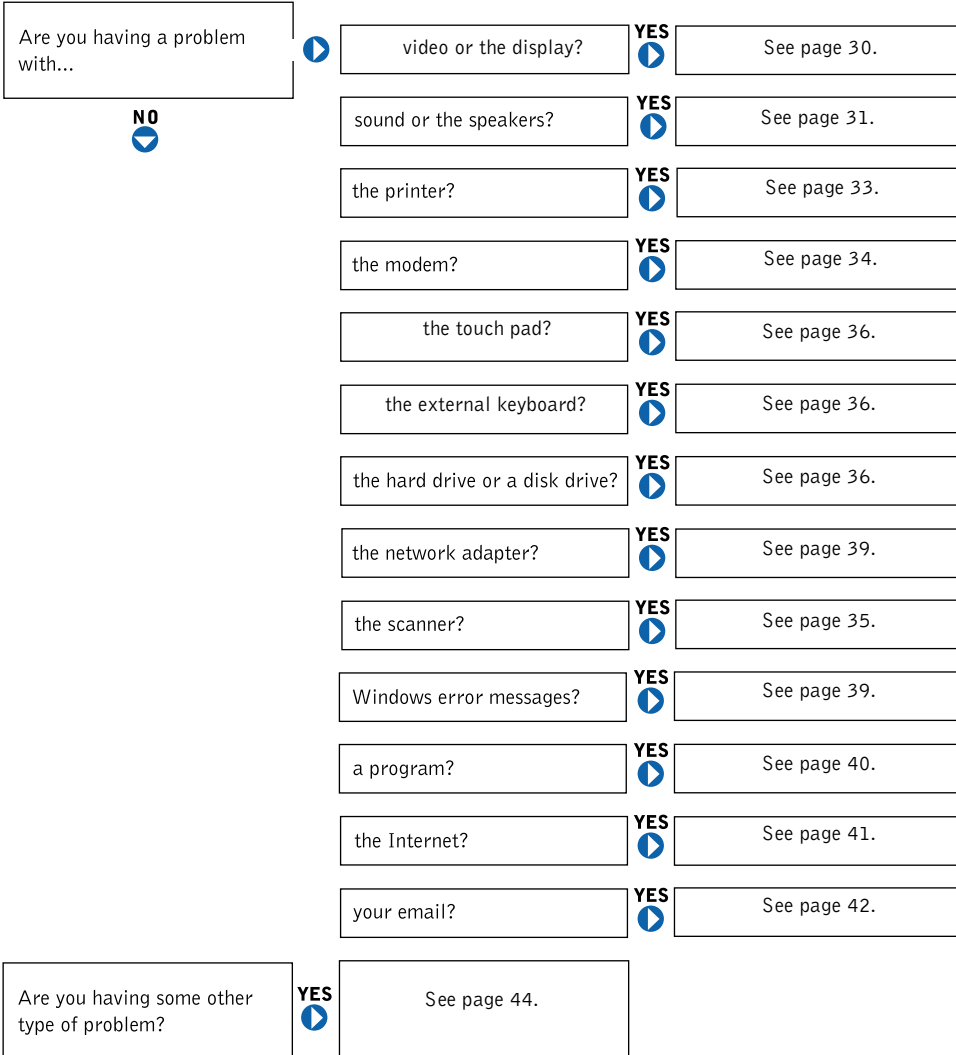

Power Problems

CHECK THE POWER LIGHT— When the power light is lit or blinking, the computer has power. If the power light is blinking, the computer is in standby mode—press the power button to resume from standby mode.

TEST THE ELECTRICAL OUTLET— Ensure that the electrical outlet is working by testing it with another device, such as a lamp.

CHECK THE AC ADAPTER— Be sure that the power cable is firmly inserted into the electrical outlet and the green light on the AC adapter is on.

CONNECT THE COMPUTER DIRECTLY TO AN ELECTRICAL OUTLET— Bypass power protection devices, power strips, and the extension cable to verify that the computer turns on.

CHECK FOR INTERFERENCE— Electrical appliances on the same circuit or operating near the computer can cause interference. Other causes of interference: power extension cables, too many devices on a power strip, or multiple power strips connected to the same electrical outlet.

CHECK THE POWER PROPERTIES— See the *Tell Me How* help file or *Windows Help*.

To access *Windows Help*:

- 1 Click the **Start** button and then click **Help**.
- 2 Click the **Search** tab.
- 3 Type `standby` and then click **List Topics**.
- 4 Click **To change the elapsed time before your computer automatically goes on standby**.

 **HINT:** See the *Tell Me How* help file for information on the standby mode.

Start-Up Error Messages

OPERATING SYSTEM NOT FOUND—Call Dell for technical assistance (see page 76).

INSERT BOOTABLE MEDIA—The operating system is trying to boot to a nonbootable floppy disk or CD. Insert a bootable floppy disk or CD.

NON-SYSTEM DISK ERROR—A floppy disk is in the floppy drive. Remove the floppy disk and restart the computer.

Video and Display Problems

If the display is blank

CHECK THE POWER PROPERTIES—See *Windows Help*.

To access *Windows Help*:

- 1 Click the **Start** button and then click **Help**.
- 2 Click the **Search** tab.
- 3 Type **standby** and then click **List Topics**.
- 4 Click **To change the elapsed time before your computer automatically goes on standby**.

If the display is difficult to read

ADJUST THE BRIGHTNESS—See the *Tell Me How* help file for instructions on adjusting the brightness.

MOVE THE SUBWOOFER AWAY FROM THE COMPUTER OR MONITOR—If your external speaker system includes a subwoofer, ensure that the subwoofer is at least 6 cm (2 ft) away from the computer or external monitor.

ELIMINATE POSSIBLE INTERFERENCE— Turn off nearby fans, fluorescent lights, or halogen lamps to check for interference.

ROTATE THE COMPUTER TO FACE A DIFFERENT DIRECTION— Eliminate sunlight glare, which can cause poor picture quality.

RESTORE THE RECOMMENDED SETTINGS— Restore the original resolution and refresh rate settings. See the *Tell Me How* help file for instructions.

ADJUST THE WINDOWS DISPLAY SETTINGS—

- 1 Click the **Start** button, point to **Settings**, and then click **Control Panel**.
- 2 Double-click the **Display** icon and then click the **Settings** tab.
- 3 Try different settings for **Colors** and **Screen area**.

Sound and Speaker Problems

Integrated Speakers

ADJUST THE WINDOWS VOLUME CONTROL— Double-click the yellow speaker icon in the lower-right corner of your screen. Be sure that the volume is turned up and that the sound is not muted.

CHECK THE VOLUME CONTROL BUTTONS— Press both volume control buttons simultaneously or press <Fn><End> to disable (mute) or reenable the integrated speakers.

REINSTALL THE SOUND (AUDIO) DRIVER— See page 44.

 **HINT:** The volume control in some MP3 players overrides the Windows volume setting. If you have been listening to MP3 songs, make sure that you did not turn the player volume down or off.

External Speakers

VERIFY THE SPEAKER CABLE CONNECTIONS— Ensure that the speakers are connected as shown on the setup diagram supplied with the speakers.

TEST THE ELECTRICAL OUTLET— Ensure that the electrical outlet is working by testing it with another device, such as a lamp.

ENSURE THAT THE SPEAKERS ARE TURNED ON— See the setup diagram supplied with the speakers.

ADJUST THE SPEAKER CONTROLS— Adjust the volume, bass, or treble controls to eliminate distortion.

ADJUST THE WINDOWS VOLUME CONTROL— Double-click the yellow speaker icon in the lower-right corner of your screen. Be sure that the volume is turned up and that the sound is not muted.

TEST THE SPEAKERS— Plug the speaker audio cable into the headphone connector on the side of the computer. Ensure that the headphone volume control is turned up. Play a music CD.

RUN THE SPEAKER SELF-TEST— Some speaker systems have a self-test button on the subwoofer. See the speaker documentation for self-test instructions.

MOVE THE SUBWOOFER AWAY FROM THE COMPUTER OR MONITOR— If your external speaker system includes a subwoofer, ensure that the subwoofer is at least 6 cm (2 ft) away from the computer or external monitor.

ELIMINATE POSSIBLE INTERFERENCE— Turn off nearby fans, fluorescent lights, or halogen lamps to check for interference.

REINSTALL THE SOUND (AUDIO) DRIVER— See page 44.

Printer Problems

If you cannot print to a parallel port printer

VERIFY THE PRINTER CABLE CONNECTIONS— Ensure that the printer cable is connected as described on page 18.

TEST THE ELECTRICAL OUTLET— Ensure that the electrical outlet is working by testing it with another device, such as a lamp.

ENSURE THAT THE PRINTER IS TURNED ON— See the documentation supplied with the printer.

VERIFY THAT THE PRINTER IS RECOGNIZED BY WINDOWS

- 1 Click the **Start** button, point to **Settings**, and then click **Printers**.
If the printer is listed, right-click the printer icon, click **Properties**, and then select the **Details** tab.
- 2 Ensure that the **Print to the following port:** setting is **LPT1 (Printer Port)**.

REINSTALL THE PRINTER DRIVER— See page 20.

If you cannot print to a USB printer

VERIFY THE PRINTER CABLE CONNECTIONS— Ensure that the printer cable is connected as described on page 18.

TEST THE ELECTRICAL OUTLET— Ensure that the electrical outlet is working by testing it with another device, such as a lamp.

ENSURE THAT THE PRINTER IS TURNED ON— See the documentation supplied with the printer.

VERIFY THAT THE PRINTER IS RECOGNIZED BY WINDOWS—

- 1 Click the **Start** button, point to **Settings**, and then click **Printers**.
If the printer is listed, right-click the printer icon, click **Properties**, and then select the **Details** tab.
- 2 Ensure that the **Print to the following port:** setting is **USB**.

REINSTALL THE PRINTER DRIVER— See page 20.

Modem Problems

 **NOTICE:** Connect the modem to an analog telephone jack only. Connecting the modem to a digital telephone network damages the modem.

CHECK THE TELEPHONE JACK— Disconnect the telephone line from the modem and connect it to a telephone. Listen for a dial tone.

CONNECT THE MODEM DIRECTLY TO THE TELEPHONE WALL JACK— If you have other telephone devices sharing the line, such as an answering machine, fax machine, surge protector, or line splitter, then bypass them and connect the modem directly to the telephone wall jack with the telephone line.

CHECK THE CONNECTION— Verify that the telephone line is connected to the modem.

CHECK THE TELEPHONE LINE—Try using a different telephone line. If you are using a line that is 3 m (10 ft) or more in length, try a shorter one.

VERIFY THAT THE MODEM IS COMMUNICATING WITH WINDOWS

- 1 Click the **Start** button, point to **Settings**, and click **Control Panel**.
- 2 In the **Control Panel** window, double-click **Modems**.
If there are multiple entries for the same modem or modems listed that are not installed, delete the entries and restart the computer.
- 3 Click the **Diagnostics** tab.
- 4 Click the COM port for your modem.
- 5 Click **More Info** to verify that the modem is communicating with Windows.
If all commands receive responses, the modem is operating properly.

Scanner Problems

CHECK THE POWER CABLE CONNECTION—Ensure that the scanner power cable is firmly connected to a working electrical power source and that the scanner is turned on.

CHECK THE SCANNER CABLE CONNECTION—Ensure that the scanner cable is firmly connected to the computer and to the scanner.

UNLOCK THE SCANNER—Ensure that your scanner is unlocked if it has a locking tab or button.

REINSTALL THE SCANNER DRIVER—Reinstall the scanner driver. See the scanner documentation for instructions.

Touch Pad Problems

CHECK THE TOUCH PAD SETTINGS—Click the **Start** button, select **Control Panel**, and then double-click the **Mouse** icon. Try adjusting the settings.

External Keyboard Problems

 **HINT:** External USB keyboards only function when the Windows operating system is running.

DISCONNECT THE KEYBOARD CABLE—Check the cable connector for bent or broken pins, and then restart the computer.

Unexpected Characters

DISABLE THE NUMERIC KEYPAD—Press the <NumLock> key to disable the numeric keypad. Verify that the NumLock light is not lit.

Drive Problems

If you cannot save a file to a floppy disk

 **HINT:** For information on saving files to a floppy disk, double-click the *Tell Me How* help file icon on your Windows desktop.

ENSURE THAT WINDOWS RECOGNIZES THE DRIVE—Double-click the **My Computer** icon. If the floppy drive is not listed, perform a full scan with your antivirus software to check for and remove viruses. Viruses can sometimes prevent Windows from recognizing the drive.

CANNOT SAVE FILES TO A FLOPPY DISK— Ensure that the floppy disk is not full or write-protected (locked). See the following illustration.

TEST THE DRIVE WITH ANOTHER FLOPPY DISK— Insert another floppy disk to eliminate the possibility that the original floppy disk is defective.

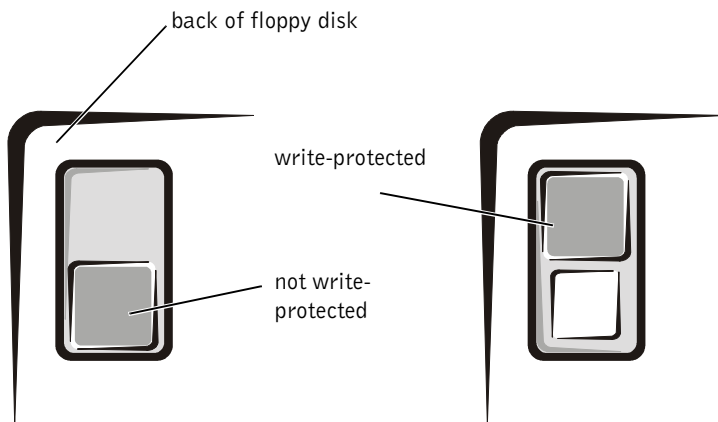

If you cannot play a music CD or install a program from a CD

ENSURE THAT WINDOWS RECOGNIZES THE DRIVE— Double-click the **My Computer** icon. If the CD drive is not listed, perform a full scan with your antivirus software to check for and remove viruses. Viruses can sometimes prevent Windows from recognizing the drive.

TEST THE DRIVE WITH ANOTHER CD— Insert another CD to eliminate the possibility that the original CD is defective.

CLEAN THE DISC— See the *Tell Me How* help file for instructions.

ADJUST THE WINDOWS VOLUME CONTROL— Double-click the yellow speaker icon in the lower-right corner of your screen. Be sure that the volume is turned up and that the sound is not muted.

 **HINT:** High-speed CD drive vibration is normal and may cause noise. This does not indicate a defect in the drive or the CD.

 **HINT:** Because of different worldwide file types, not all DVD titles work in all DVD drives.

If you cannot play a DVD movie

ENSURE THAT WINDOWS RECOGNIZES THE DRIVE— Double-click the **My Computer** icon. If the DVD drive is not listed, perform a full scan with your antivirus software to check for and remove viruses. Viruses can sometimes prevent Windows from recognizing the drive.

TEST THE DRIVE WITH ANOTHER DVD— Insert another DVD to eliminate the possibility that the original DVD is defective.

CLEAN THE DISC— See the *Tell Me How* help file for instructions.

If the CD-RW drive stops writing

CHANGE THE WRITE SPEED TO A SLOWER RATE— The CD-RW drive must receive a steady stream of data when writing. If the stream is interrupted, an error occurs. Closing all programs before writing to the CD-RW may also alleviate the problem.

If you have a hard drive problem

RUN SCANDISK— Click the **Start** button, point to **Programs**—> **Accessories**—> **System Tools**, and then click **ScanDisk**.

Network Problems

CHECK THE NETWORK CABLE CONNECTOR—Ensure that the network cable connector is firmly connected to the connector on the computer and the network wall jack.

CHECK THE NETWORK LIGHTS ON THE NETWORK CONNECTOR—Green indicates that the network connection is active. If the status light is not green, try replacing the network cable.

RESTART THE COMPUTER—Try to log on to the network again.

CONTACT YOUR NETWORK ADMINISTRATOR—Verify that your network settings are correct and that the network is functioning.

Windows Error Messages

X:\ IS NOT ACCESSIBLE. THE DEVICE IS NOT READY—Insert a disk into the drive and try again.

A FILENAME CANNOT CONTAIN ANY OF THE FOLLOWING CHARACTERS: \ / : * ? " < > |—Do not use these characters in filenames.

NOT ENOUGH MEMORY OR RESOURCES. CLOSE SOME PROGRAMS AND TRY AGAIN—You have too many programs open. Close all windows and open the program that you want to use.

THE FILE BEING COPIED IS TOO LARGE FOR THE DESTINATION

DRIVE— The file that you are trying to copy is too large to fit on the disk, or the disk is too full. Try copying the file to a different disk or use a larger capacity disk.

A REQUIRED .DLL FILE WAS NOT FOUND— The program that you are trying to open is missing an essential file. To remove and then reinstall the program:

- 1 Click the **Start** button, point to **Settings**, and then click **Control Panel**.
- 2 Double-click the **Add/Remove Programs** icon.
- 3 Select the program that you want to remove.
- 4 Click the **Add/Remove** button and follow the prompts on the screen.
- 5 See the program documentation for installation instructions.

General Program Problems

A program crashes

SEE THE SOFTWARE DOCUMENTATION— Many software manufacturers maintain websites with information that may help you to solve the problem.

A program stops responding

PRESS <CTRL> <ALT> **— In the **Close Program window, select the program that is no longer responding. Then click the **End Task** button.

A solid blue screen appears

TURN THE COMPUTER OFF— If the computer does not respond to a keystroke or a proper shutdown (see page 20), press the power button until the computer turns off. Press the power button again to restart the computer. The solid blue screen appears because you were not able to perform a proper Windows shutdown. ScanDisk will automatically run during the start-up process. Follow the instructions on the screen.

Internet Connection Problems

If you have a problem with your Dellnet account

REVIEW “SETTING UP DELLNET”— See page 16.

REVIEW “MODEM PROBLEMS”— See page 34.

TURN OFF CALL WAITING (CATCH-PHONE)— See your telephone directory for instructions on deactivating this feature. Then adjust the dial-up networking connection properties:

- 1 Click the **Start** button, point to **Settings**, and then click **Control Panel**.
- 2 Double-click the **Modems** icon.
- 3 In the **Modems Properties** window, click the **Dialing Properties** button.
- 4 Ensure that **To disable call waiting, dial:** is checked and then select the proper code according to the information in your telephone directory.
- 5 Click the **Apply** button and then click the **OK** button.
- 6 Close the **Modems Properties** window.
- 7 Close the **Control Panel** window.

E-Mail Problems

REVIEW "SENDING AND RECEIVING E-MAIL"— See page 17.

ENSURE THAT YOU ARE CONNECTED TO THE INTERNET— With the Outlook Express e-mail program open, click **File**. If **Work Offline** has a check next to it, click the check to remove it and connect to the Internet.

If Your Computer Gets Wet

⚠ CAUTION: Perform this procedure only after you are certain that it is safe to do so. If the computer is connected to an electrical outlet, Dell recommends that you turn off AC power at the circuit breaker before attempting to remove the power cables from the electrical outlet. Use the utmost caution when removing wet cables from a live power source.

- 1 Turn off the computer (see page 20), disconnect the AC adapter from the computer, and disconnect the AC adapter from the electrical outlet.
- 2 Turn off any attached peripherals and disconnect them from their power sources and then from the computer.
- 3 Ground yourself by touching one of the metal connectors on the back of the computer.
- 4 Remove the modular bay device (see page 52) and any installed PC Cards (see page 56), and put them in a safe place to dry.
- 5 Remove the battery (see page 54).
- 6 Wipe off each battery and put them in a safe place to dry.
- 7 Remove the hard drive (see page 64).
- 8 Remove the memory modules (see page 62).
- 9 Open the display, and place the computer right-side up across two books or similar props to let air circulate all around it. Let the computer dry for at least 24 hours in a dry area at room temperature.

🕒 NOTICE: Do not use artificial means to speed up the drying process.

⚠ CAUTION: To help prevent electrical shock, verify that the computer is thoroughly dry before continuing with the remainder of this procedure.

- 10** Ground yourself by touching one of the metal connectors on the back of the computer.
- 11** Replace the memory modules, and the memory module cover and screw (see page 62).
- 12** Replace the hard drive and screw (see page 64).
- 13** Replace the modular bay device (see page 52) and any PC Cards (see page 56).
- 14** Replace the battery (see page 54).
- 15** Turn on the computer.

If the computer does not turn on, or if you cannot identify the damaged components, call Dell for technical assistance (see page 76).

If You Drop or Damage Your Computer

- 1** Save and close any open files, exit any open application programs, and shut down the computer (see page 20).
- 2** Disconnect the AC adapter from the computer, and disconnect the AC adapter from the electrical outlet.
- 3** Turn off any attached peripherals and disconnect them from their power sources and then from the computer.
- 4** Remove and reinstall the battery.
- 5** Turn on the computer.

If the computer does not turn on, or if you cannot identify the damaged components, call Dell for technical assistance (see page 76).

Resolving Other Technical Problems

GO TO THE DELL SUPPORT WEBSITE—Go to <http://support.dell.com> for help with general usage, installation, and troubleshooting questions.

E-MAIL DELL—Go to <http://support.dell.com> and then click **E-Mail Dell** in the **Communicate** list. Send an e-mail message to Dell about your problem; you can expect to receive an e-mail message from Dell within hours.

CALL DELL—If you cannot solve your problem using the Dell support website or e-mail service, call Dell for technical assistance (see page 76).

Reinstalling Drivers and Utilities



NOTICE: The Dell support website, <http://support.dell.com>, and the *System Software* CD provide approved drivers for Dell™ computers. If you install drivers obtained from other sources, your computer might not work correctly.

To install drivers and utilities:

- 1 Insert the *System Software* CD into the CD or DVD drive.
- 2 Double-click the **My Computer** icon on your desktop.
- 3 Double-click the icon for your CD or DVD drive.
- 4 Double-click the folder for your operating system.
- 5 Double-click the folder for the driver you want to install.
- 6 Double-click the **setup.exe** file and follow the prompts.

For detailed information on installing specific drivers and utilities for your computer, see Dell's support website at <http://support.dell.com>.

 **HINT:** You may need to open more folders to find the **setup.exe** file. For example, to install the Windows 98 touch pad driver, double-click **win98**, double-click **touchpad**, double-click **english**, and then double-click **setup.exe**.

Reinstalling Windows

Reinstalling Windows Me and Windows 98

 **NOTICE:** The *Dell Product Recovery* CD provides options for reinstalling your Windows Me or Windows 98 Second Edition (SE) operating system. The options can potentially overwrite files installed by Dell and possibly affect programs installed on your hard drive. Therefore, Dell does not recommend that you reinstall your operating system unless instructed to do so by a Dell technical support representative.

 **NOTICE:** To prevent conflicts with Windows Me or Windows 98, you must disable any virus protection software installed on your system before you reinstall Windows.

- 1 Turn on the computer and enter the system setup program as directed by a Dell technical support representative.
- 2 In the system setup program **Boot** menu, change the boot sequence so that the CD or DVD drive boots first as directed by a Dell technical support representative. Then place the *Dell Product Recovery CD* in the CD or DVD drive and close the drive tray.
- 3 Exit the system setup program.
- 4 At the **Welcome** window, click **OK**.
- 5 Double-click **Refresh Windows OS**.
- 6 Click **OK**.
- 7 Click **OK** again.
- 8 Remove the *Dell Product Recovery CD* from CD or DVD drive, and click **OK** to restart your computer.

The **Getting ready to run Windows for the first time** window appears.

- 9 If the mouse tutorial starts, press <Esc> to exit and then press **y**.
- 10 Click the regional setting closest to where you live and click **Next**.
- 11 Click your keyboard layout and click **Next**.
- 12 In the **User Information** window, type your name and, if applicable, company name, and then click **Next**.

The **Name** field must be completed; the **Company Name** field is optional.

The **License Agreement** window appears.

- 13** Click **I accept the Agreement**, and then click **Next**.
- 14** Type the Windows product key in the fields provided, and then click **Next**.

The product key is the bar code number found on the Microsoft Windows label, which is located on the computer.

- 15** When the **Start Wizard** appears, click **Finish**.

The **Enter Windows Password** window appears. To continue without creating a Windows user name and password, click **OK**. Otherwise, type your user name and password in the appropriate fields and then click **OK**.

- 16** If the **Date/Time Properties** window appears, adjust the date and time properties, click **Apply**, and then click **OK**.

Windows updates the system settings and restarts your computer.

- 17** If you created a Windows user name and password, type your password and click **OK**.



NOTICE: Make sure that you reinstall the Intel Chip Set Update Utility driver *before* you reinstall any other drivers.

- 18** Reinstall the appropriate drivers (see page 44).
- 19** Reenable your virus protection software.

Reinstalling Windows 2000

- 1** Insert the *Dell Products Recovery CD* into the CD or DVD drive.
- 2** Shut down the computer (see page 19).
- 3** Turn on the computer.
- 4** Press any key when the **Press any key to boot from CD** message appears on the screen.
- 5** When the **Windows 2000 Setup** window appears, ensure that the **To setup Win2000 now, press ENTER** option is highlighted. Then press <Enter>.
- 6** Read the information in the **License Agreement** window, and then press <F8> to continue.

- 7 When the **Windows 2000 Professional Setup** window appears, use the arrow keys to select the Windows 2000 partition option that you want. To continue, press the key specified in the partition option that you chose.
- 8 When the **Windows 2000 Professional Setup** window reappears, use the arrow keys to select the type of filing system that you want Windows 2000 to use, and then press <Enter>.
- 9 Press <Enter> again to restart your computer.
- 10 Click **Next** when the **Welcome to the Windows 2000 Setup Wizard** window appears.
- 11 When the **Regional Settings** window appears, select the settings for your locale, and then click **Next**.
- 12 Enter your name and organization in the **Personalize Your Software** window, and then click **Next**.
- 13 When prompted, enter the Windows product key, which is printed on the Microsoft label on your computer. Then click **Next**.
- 14 When the **Computer Name and Administrator Password** window appears, enter a name for your computer and a password, if desired. Then click **Next**.
- 15 Enter the date and time in the **Date and Time Settings** window, and then click **Next**.

Windows 2000 now begins to install its components and configure the computer.
- 16 When the **Completing the Windows 2000 Setup Wizard** window appears, remove the CD from the drive, and then click **Finish**. The computer automatically restarts.

Recreating the Hibernate File (Windows 98 Only)

When hibernate mode is activated, all system data is stored in the hibernate file on your hard drive. The hibernate file cannot be accessed by the Windows operating system or application programs.

 **HINT:** Windows Me and Windows 2000 recreate the hibernate file automatically.

 **HINT:** If you install additional memory, you must delete the original hibernate file before recreating a new one.

You must recreate the hibernate file if you perform any of the following actions:

- Delete the hibernate file.
- Install a new hard drive.
- Reformat your hard drive.
- Install additional memory.

Boot (Restart) Your Computer With the *System Software CD*

- 1** Save and close any open files, exit any open application programs, and shut down the computer.
- 2** If the computer is connected to a port replicator, undock it (see page 58).
- 3** Turn on the computer.
- 4** Press <F2> when you see the Dell logo to access the system setup program.
- 5** Press the right-arrow key to highlight **Boot**.
- 6** Press the down-arrow key to highlight a device, and then press <F5> or <F6> to move the device up or down the list until they are in the following sequence:
 - Floppy
 - CD ROM/DVD
 - Internal Hard Drive
- 7** Insert the *System Software CD* into the CD or DVD drive.
- 8** Press <F10> to save your changes and exit the system setup program.
- 9** When the **Setup Confirmation** window appears, press <Enter> to confirm the configuration changes and exit the system setup program.
- 10** After the computer restarts and loads the diagnostic utility, press the down-arrow key to select **Exit to MS-DOS** and then press <Enter>.

Delete the Old Hibernate File

- 1** Boot your computer from the *System Software CD* as described the preceding section.

- 2 At the `R:\DIAGS` prompt, type `cd\` and press <Enter>.
- 3 At the `R:\` prompt, type `cd\utility` and press <Enter>.
- 4 Type `phdisk /delete /file` and press <Enter>.
- 5 Follow the instructions on your screen to delete the hibernate file.

 **HINT:** You must type a space between `phdisk` and `/delete` and `/file`.

Create the Hibernate File

- 1 Boot your computer from the *System Software* CD as described the preceding section, and then exit to MS-DOS.
- 2 At the `R:\DIAGS` prompt, type `cd\` and then press <Enter>.
- 3 At the `R:\` prompt, type `cd\win98\utility` and press <Enter>.
- 4 Type `phdisk /create /file` and press <Enter>.
- 5 Follow the instructions on your screen to create the hibernate file.
- 6 At the `R:\WIN98\UTILITY` prompt, type `phdisk /info` and press <Enter>.
- 7 When the Dell logo appears on your screen, remove the *System Software* CD from the CD or DVD drive.
- 8 Enable hibernate support in Windows 98.

 **HINT:** You must type a space between `phdisk` and `/create` and `/file`.

Enable Hibernate Support

- 1 Click the **Start** button, point to **Settings**, and click **Control Panel**.
- 2 Double-click the **Power Management** icon.
- 3 Click the **Hibernate** tab.
- 4 Ensure that **Enable hibernate support** is selected and click **Apply**.
- 5 Click **OK** to close the **Control Panel** window.

SECTION 3

Adding Parts

Using the Modular Bay

Installing a Battery

Docking the Computer

Adding Memory

Replacing a Hard Drive

Using the Modular Bay

Dell ships your computer with a CD drive (or an optional DVD drive) installed in the modular bay. The modular bay also supports the following devices:

- CD drive
- CD-RW drive
- DVD drive
- Zip drive
- Floppy drive
- Second battery



NOTICE: To prevent irreparable damage to the docking connector, do not remove or replace devices while the computer is connected to a port replicator.

Swapping Devices While the Computer Is Turned Off

- 1 Save and close any open files, exit any open application programs, and shut down the computer (see page 20).
- 2 If the computer is connected to a port replicator, undock it (see page 58).
- 3 Close the display and turn the computer over.
- 4 Slide and hold the latch release and pull the module out.

NOTICE: To prevent damage, place devices in a travel case when they are not inserted in the computer. Store devices in a dry, safe place, and avoid placing heavy objects on top of them.

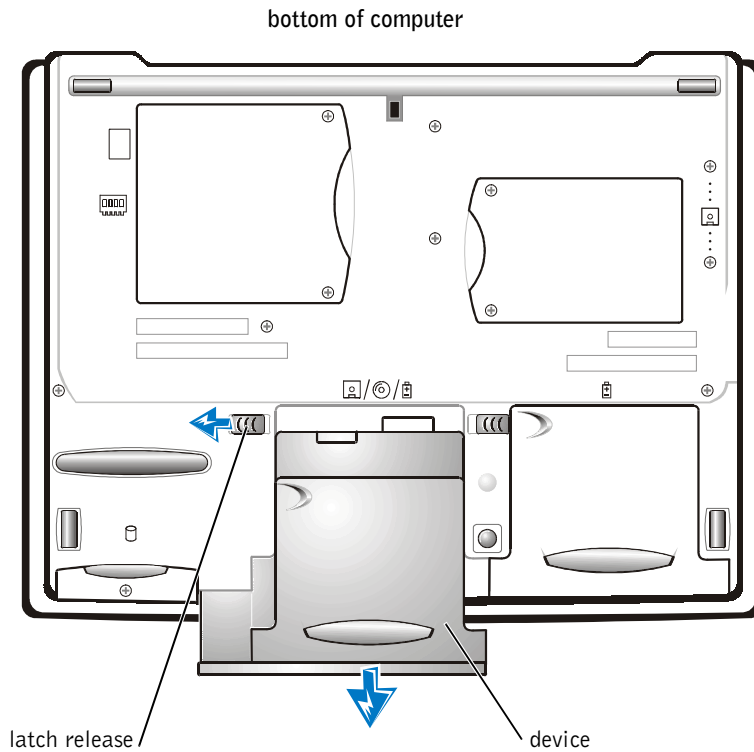

NOTICE: Insert the device before you dock and turn on the computer.

- 5 Insert the new device and push it until you hear a click.
- 6 Turn on the computer.

Swapping Devices While the Computer Is Turned On

NOTICE: To prevent irreparable damage to the docking connector, do not remove or replace devices while the computer is connected to a port replicator.

In Microsoft Windows 98 or Windows Me

- 1 Right-click the **Softex BayManager** icon on the Microsoft Windows taskbar.
- 2 Click **Remove/Swap**.
- 3 Close the display and turn the computer over.
- 4 Slide and hold the latch release and pull the module out.
- 5 Insert the new device and push it until you hear the latch release click.
- 6 Click **OK**.

In Microsoft Windows 2000

- 1 Double-click the **Unplug or Eject Hardware** icon on the Microsoft Windows taskbar.
- 2 Click the device you want to eject and then click **Stop**.
- 3 Click **OK** to prepare the device and activate standby mode.
- 4 Close the display and turn the computer over.
- 5 Slide and hold the latch release and pull the device out.
- 6 Insert the new device and push it until you hear a click.
- 7 Press the power button to resume from standby.
- 8 Type in your password to unlock your computer.
- 9 When Windows resumes and recognizes the new device, click **Close**.

 **HINT:** Wait for the computer to enter standby mode before removing the device. The computer is in standby mode when the power light flashes.

Installing a Battery

 **NOTICE:** Your battery is designed to work only with Dell Inspiron 5000 series computers. Using other batteries may damage your computer.

 **HINT:** You can also install a second battery in the modular bay (see page 54).

- 1 Save and close any open files, exit any open application programs, and shut down the computer (see page 20).
- 2 If the computer is attached (docked) to a port replicator, undock it (see page 58).

 **NOTICE:** To avoid data loss, do not replace a battery while the computer is turned on unless the computer is connected to an electrical outlet or a second battery is installed.

- 3 If the modular bay contains a battery, go to step 5. If the only battery in the computer is in the battery bay, continue to step 4.
- 4 Connect the computer to an electrical outlet and then preserve your data in one of the following ways:
 - Press <Fn><Esc> to activate the standby mode. Then shut down the computer.
 - Press <Fn><a> (or <Fn><q> on a French keyboard) to activate hibernate mode. When the power light turns off, continue to step 5.
- 5 Close the display and turn the computer over.
- 6 Slide the battery bay latch with one hand, and pull the battery out of the bay with the other hand.

Installing a Second Battery in the Modular Bay

 **NOTICE:** To avoid data loss, do not replace a battery in the modular bay while the computer is turned on unless the computer is connected to an electrical outlet or a battery is already installed in the battery bay.

- 1 Save and close any open files, exit any open application programs, and shut down the computer (see page 20).
- 2 If the computer is docked, undock it (see page 58).
- 3 Close the computer display and turn the computer over.
- 4 Slide and hold the modular bay latch to release the device in the modular bay, and pull the device out of the bay with the other hand.
- 5 Slide the new battery firmly into the modular bay until it clicks.
You should hear a click when the battery is fully seated.
- 6 Press the power button to resume normal operation.

 **HINT:** If you encounter too much resistance when you insert the card, do not force the card. Check the card's orientation, and try again.

PC Cards

Installation

- 1 Hold the card with its orientation symbol pointing into the slot and the top side of the card facing up.
- 2 Insert the card into the slot, and press in firmly until the card is completely seated in the internal PC Card connector.

Removal

- 1 Press the eject button.
- 2 When the button slides out, press it again to release the card.
- 3 Gently remove the card.
- 4 Press the eject button again until it is flush with the computer casing.

Docking the Computer

 **HINT:** If you receive a BIOS upgrade floppy disk with your port replicator, use the disk to upgrade your computer before you use the port replicator.

You *dock* your computer when you connect it to a port replicator. The port replicator integrates your computer into a desktop environment.

The advanced port replicator (APR) includes a network interface controller (NIC) to connect your computer to a network. Before you connect your computer to an APR, perform the operating system setup.

Connecting to a Port Replicator

- 1 Save and close any open files, exit any open application programs, and shut down the computer (see page 20).
- 2 Connect the AC adapter to the connector on the port replicator and plug the AC power cable into an electrical outlet.

- 3 Place the computer on the port replicator platform with the back of the computer facing the docking connector.

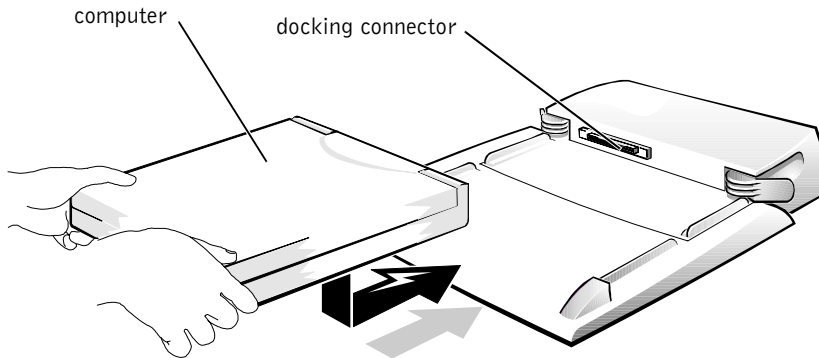

- 4 Position your fingers on the platform grips, and push the computer forward with your thumbs until the docking connectors are fully engaged.

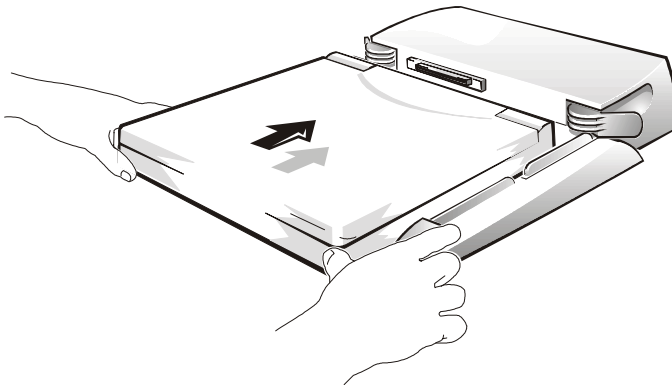

- 5 Turn on the computer.

NOTICE: Do not lift the computer while it is docked, or you will damage the docking connector.

HINT: The video resolution defaults to 640 x 480 when you insert the computer into the port replicator. See the *Tell Me How* help file for information on how to change the display resolution.

Detaching (Undocking) From a Port Replicator

- 1 Save and close any open files, exit any open application programs, and shut down the computer (see page 20).
- 2 Pull both release handles on the sides of the port replicator.

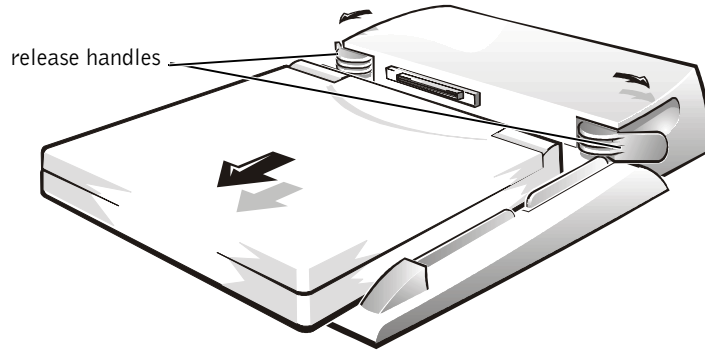

Connecting External Devices to a Port Replicator

The connectors on the back of the port replicator duplicate the primary connectors on the back and sides of your computer.

- 1 Attach external devices to the appropriate connectors on the back of the port replicator. See page 59 for a description of each connector.

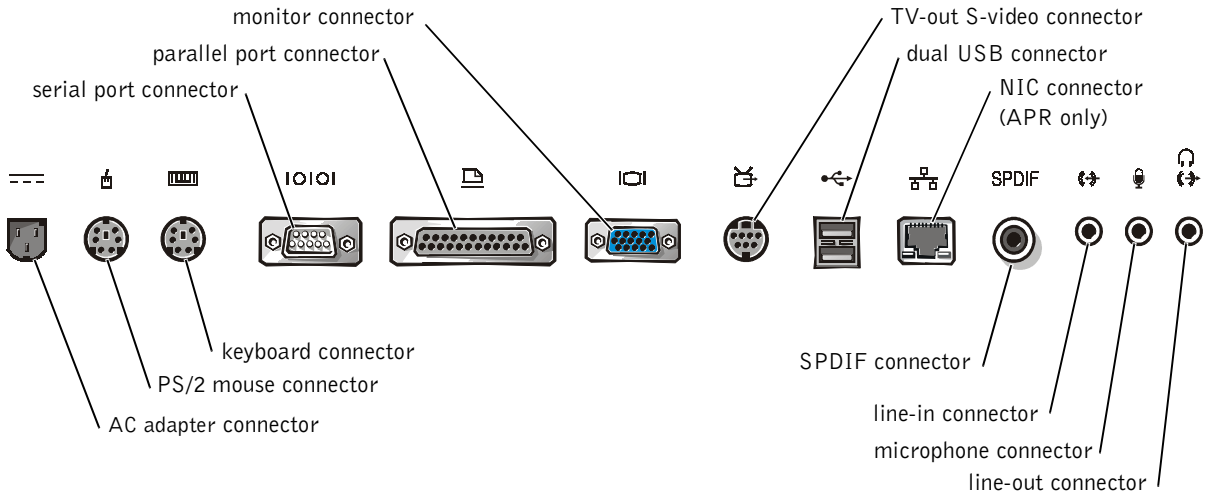

NOTICE: Before attaching any cables, verify that the connector pins are aligned correctly to avoid damaging the connectors.



- 2 If the cable connector from the external device has thumbscrews, tighten them for a proper connection.
- 3 Connect the external devices to an electrical outlet, if applicable.

Connectors on a Port Replicator

The following table shows the icons for each of the connectors on the back of the port replicator and indicates the type of external device(s) that you can attach to each connector.

Connector Icons	External Devices
	Connect the AC adapter that came with the port replicator.
	Connect a PS/2-style mouse.
	Connect a PS/2-style keyboard or numeric keypad.

Connector Icons



External Devices

Connect a serial device, such as a serial mouse or digital camera.



Connect a parallel device, such as a printer.



Connect a monitor.



Connect a television.



Connect one or two USB devices, such as a USB mouse.



Connect a network interface cable (APR only). The yellow indicator lights up when connected to a 100-Mbps network. The green indicator flashes when data is being transferred.

SPDIF

Connect external speakers or home audio equipment to the Sony Phillips Digital Interface (SPDIF) audio output connector.

HINT: No software solution exists for the SPDIF port on this computer. See support.dell.com for updates.



Connect headphones or a speaker.



Connect a record/playback audio device, such as a cassette player, CD player, or VCR.



Connect a microphone.

Buttons and Indicators

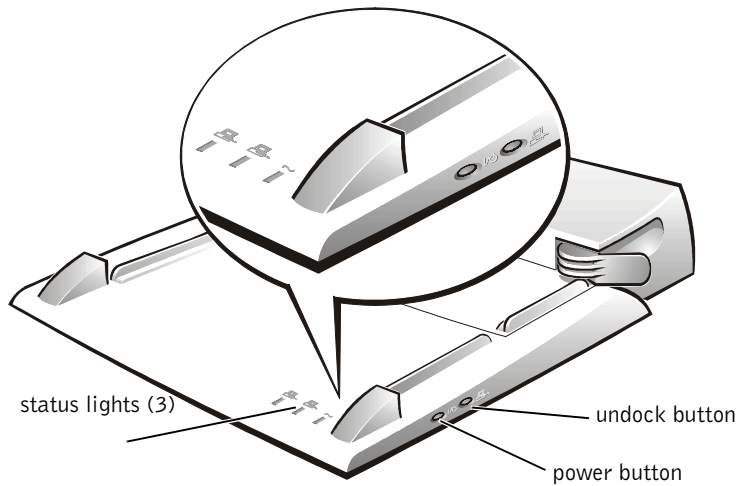

Button	Function
Power button	The power button is set to turn your computer on and off. Pressing this button is the equivalent of pressing your computer's power button.
Undock button	The undock button activates standby mode on the computer. When you press the port replicator's undock button to undock the computer, you must open the display and press the power button on the computer to resume operation.

 **NOTICE:** Do not use the undock button to remove the computer from the port replicator unless you have a battery installed.

Button	Function
Status lights	<p>The left light turns on when the computer is attached to the port replicator and is turned on.</p> <p>The center light turns on when you press the undock button, or when the computer is placed in standby mode.</p> <p>The right light turns on when the port replicator is connected to an electrical outlet.</p>

Adding Memory

 **HINT:** Memory modules purchased from Dell are covered under your computer

You can increase your computer memory by installing memory modules on the system board. See page 68 for information on the type of memory supported by your computer.

Your computer has two memory module sockets. All Dell memory modules (except the 192-MB capacity module) can be installed in either socket.

 **NOTICE:** The 192-MB memory modules are socket-specific. Before installing a 192-MB memory module, refer to the markings on the memory module to determine which socket accepts the module.

 **CAUTION:** Before working inside your computer, read the “Safety Instructions” at the front of this guide (see page 5).

 **NOTICE:** Do not install or remove a memory module when the computer is turned on, in standby mode, or in hibernate mode.

- 1 Save and close any open files, exit any open application programs, and shut down the computer.
- 2 Remove all installed batteries and any external devices, and disconnect the AC adapter cable from the computer.
- 3 Ground yourself by touching a metal connector on the back of the computer.

- 4 Turn the computer over, remove the screws, and lift up the memory module cover.

bottom of computer

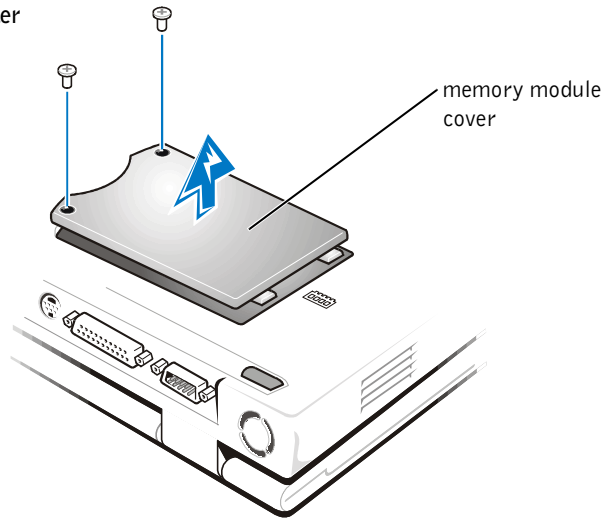

NOTICE: To prevent damage to the computer, do not use tools to spread the inner metal tabs of the socket when you are installing or removing a memory module.

- 5 To remove a memory module, use your fingernails to carefully spread apart the securing clip slightly to disengage the module from the socket (the module should pop up). Then lift the memory module away from the socket.

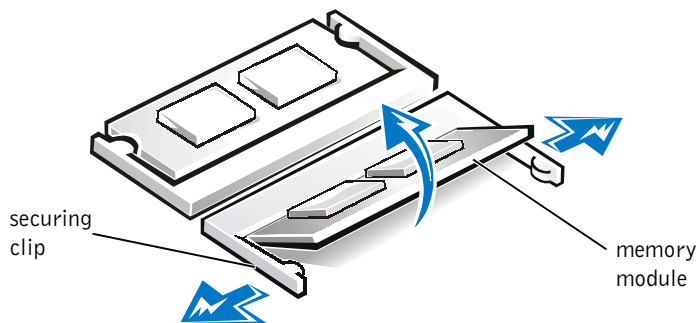

- 6 Insert the memory module:
 - a Align the notch in the module with the slot in the center of the socket.
 - b Press the module firmly into the socket and pivot it down until it clicks.

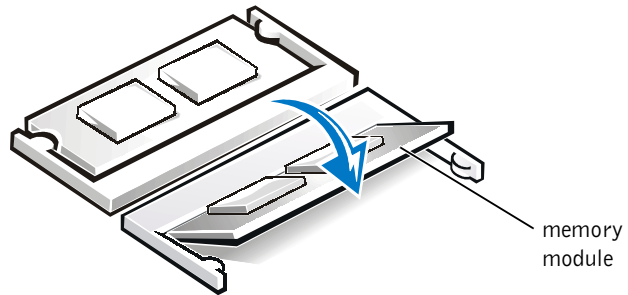

- 7 Replace the cover and screws.
- 8 Reinsert the battery, or attach the AC adapter to your computer and an electrical outlet.
- 9 Turn on the computer.
- 10 If your computer uses Windows 98, delete and recreate the hibernate (save-to-disk suspend) file on your hard drive to accommodate the new memory (see page 47).

HINT: If the memory module is not installed properly, the computer will not boot. No error message indicates this failure.

HINT: Dell neither guarantees compatibility nor provides support for hard drives from sources other than Dell.

Replacing a Hard Drive

NOTICE: Hard drives are extremely fragile and must be handled carefully. Even a slight bump can damage the drive.

CAUTION: If you remove the hard drive from the computer when the drive is hot, *do not touch* the metal housing of the hard drive.

NOTICE: To prevent data loss, turn off your computer before removing or installing a hard drive. Do not remove the hard drive while the computer is in standby mode or hibernate mode, or if the power light is lit.

- 1 Save and close any open files, exit any open application programs, and shut down the computer.
- 2 Remove all installed batteries and disconnect the AC adapter cable and any external devices from the computer.
- 3 Turn the computer over, and remove the hard drive screw.

HINT: You need the Microsoft Windows Installation CD to install Windows operating system. You also need the *System Software* CD to install the device drivers and utilities on the new hard drive.

bottom of computer

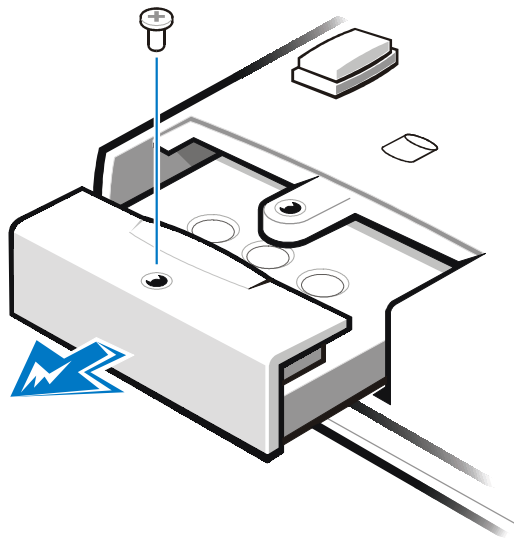

NOTICE: When the hard drive is not in the computer, protect the drive from exposure to static electricity by storing it in protective antistatic packaging.

- 4 Slide the hard drive out of the computer.
- 5 Remove the new drive from its packaging.
Save the original packaging to use when storing or shipping the hard drive.
- 6 Slide the new drive into the computer.

NOTICE: Do not force the drive into the computer. If you experience some resistance, use firm and even pressure to slide the drive into place.

- 7 Replace and tighten the screw you removed in step 3.
- 8 Install the Dell-provided operating system, the drivers, and the utilities (see page 44).

Returning a Hard Drive to Dell

Return your old hard drive to Dell in its original foam packaging. Otherwise, the hard drive may be damaged in transit.

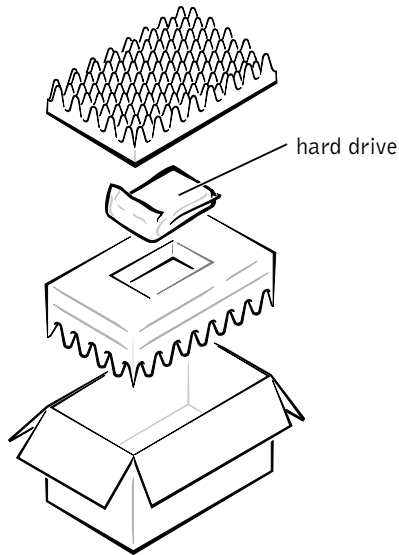

SECTION 4

Appendix

- Specifications
- Standard Settings
- Contacting Dell
- Regulatory Information
- Warranty and Return Policy Information

Specifications

Microprocessor

Microprocessor type	Intel® mobile microprocessor
L1 cache	32 KB (internal)
L2 cache	128- or 256-KB (integrated) SRAM
Math coprocessor	internal to microprocessor

System Information

System chip set	Intel mobile 440BX AGP
Data bus width	64 bits
DRAM bus width	64 bits
Microprocessor address bus width	32 bits
Flash EPROM	4 Mb

PC Card

PCI controller	Texas Instruments PCI 1225 CardBus controller
PC Card connectors	two (supports two Type I or Type II cards or one Type III card)
Cards supported	3.3 V and 5 V
PC Card connector size	68 pins
Data width (maximum)	32 bits

Memory

Architecture	SDRAM
Memory capacities	32, 64, 128, 192, and 256 MB
Minimum memory	64 MB (non-ECC)
Maximum memory	512 MB (non-ECC)
Frequency	100 MHz

Ports and Connectors

Serial	9-pin connector; 16550C-compatible
Parallel	25-hole connector; bidirectional, normal, PS/2, EPP 1.9, or ECP
Video	15-hole connector
Audio	three connectors for microphone-in, line-out, and line-in
TV-out	S-video (composite video supported with adapter cable)
PS/2 keyboard/mouse	6-pin mini-DIN connector
USB	one 4-pin USB-compliant connectors
Infrared	IrDA 1.1 sensor
Expansion/docking	240-pin connector

Video

Video type	64-bit (128-bit hardware-accelerated) AGP
Video controller	8- or 16-MB ATI M3 AGP
Video memory	8- or 16-MB, 125-MHz SDRAM
LCD interface	LVDS
TV support	NTSC or PAL in S-video and composite modes

Audio

Audio type	Sound Blaster Pro-compatible voice and music functions, HRTF 3D positional audio, hardware wavetable
Audio controller	ESS Technology Maestro-2E
Conversion	16-bit (stereo analog-to-digital and digital-to-analog)
FM music	20 voice, 72 operator
Interfaces:	
Internal	PCI bus, microphone, dual stereo speakers
External	microphone-in, line-out, line-in
Internal speaker amplifier	1.0-W stereo (0.5 W per speaker)
External microphone input voltage range	280 mV peak to peak
Line/audio input voltage range	2.8 V peak to peak
Volume controls	keyboard commands, volume buttons, application program menus

Display

Type	Active-matrix color TFT
Response time (typical)	80 ms
Operating angle	0° (closed) to 140°
Dot pitch	0.264 mm
Power consumption	3.9 W
Controls	brightness can be controlled through key combinations

Keyboard

Number of keys	87 (U.S. and Canada); 88 (Europe); 90(Japan)
Key travel	3.0 ± 0.5 mm (0.12 ± 0.02 inch)
Key spacing	19.1 mm (0.75 inch)
Layout	QWERTY/AZERTY/Kanji

Touch Pad

Interface	PS/2 compatible
X/Y position resolution (graphics table mode)	20 points/mm (500 points/inch)
Size:	
Thickness	4.65 mm (0.18 inch) at highest component
Width	64-mm (2.52-inch) sensor-active area
Height	47.0-mm (1.85-inch) rectangle with 0.5-mm (0.02-inch) tabs
Weight	15 g (0.52 ounce) ± 0.5 g (0.001 ounce)
Power:	
Supply voltage	5 V ± 10%
Supply current	4 mA (maximum operating current)

Battery

Type	lithium ion
Dimensions:	
Depth	148.2 mm (5.83 inches)
Height	23.8 mm (0.94 inch)
Width	116.2 mm (4.58 inches)
Weight	0.43 to 0.46 kg (0.98 to 1.01lb)
Voltage	11.1 VDC
Charge time (approximate) ¹	
Computer on	3 hours
Computer off	2 hours
Operating time (approximate):	2 to 3 hours with a single battery, 4 to 6 hours with an additional battery installed in the modular bay
Life span (approximate)	350 discharge/charge cycles
Temperature range:	
Charge	5° to 35°C (41° to 95°F)
Discharge	5° to 35°C (41°F to 95°F)
Storage	-20° to 50°C (-4° to 122°F)

AC Adapter

Input voltage	100 to 240 VAC
Input current (maximum)	1.5 at 90 VAC, full load
Input frequency	50 to 60 Hz
Output current	3.5 A (continuous)
Output power	70 W
Rated output voltage	20 VDC
Dimensions:	
Height	30 mm (1.2 inches)
Width	62.0 mm (2.4 inches)
Depth	110 mm (4.3 inches)
Weight (with cables)	0.32 kg (0.71 lb)
Temperature range:	
Operating	0° to 40°C (32°F to 104°F)
Storage	-20° to 65°C (-4°F to 149°F)

Environmental

Temperature:

Operating 5° to 35°C (41° to 95°F)

Storage -20° to 50°C (-4° to 122°F)

Relative humidity 10% to 90% (noncondensing)

Maximum vibration:

Operating 0.9 GRMS using a random-vibration spectrum that simulates shipment by air

Storage 1.3 GRMS using a random-vibration spectrum that simulates shipment by truck

Maximum shock:

Operating 1.52 m/sec (60 inches/sec) (less than or equal to a pulse width of 2 ms)

Storage 2.03 m/sec (80 inches/sec) (less than or equal to a pulse width of 2 ms)

Altitude:

Operating 0 to 3048 m (0 to 10,000 ft)

Storage 0 to 12,192 m (0 to 40,000 ft)

Standard Settings

The system setup program contains the standard settings for your computer.



NOTICE: Unless you are an expert computer user, don't change the settings for this program. Certain changes might make your computer work incorrectly.

System Setup Screens

The system setup screens are organized into the following sections:

- The menu bar at the top provides access to the main program screens:
 - **Main** provides settings for the basic computer configuration.

- **System Devices** provides detailed settings for some computer features.
 - **Security** provides indications and settings for user and setup passwords.
 - **Power** provides options for customizing your computer's power settings.
 - **Boot** provides information about how the computer starts.
 - **Exit** provides selections for saving and loading the program settings.
- The left side lists configuration options and their settings for the hardware installed in your computer.

You can change settings enclosed in brackets, but not those that are grayed out. Options identified by an arrowhead (>) provide access to submenus.

 **HINT:** To see information about a specific item, highlight the item and refer to the **Item Specific Help** area on the screen.

See the following figure for an example of the **Main** screen of the program.

PhoenixBIOS Setup Utility			
Main	System Devices	Security	Power
			Boot
			Exit
System Time	[00:06:57]		Item Specific
System Date:	[11/09/99]		
Floppy Drive:	Enabled		
Hard Disk:	4871MB		
Quiet Boot:	[Enabled]		
Video Display Device:	[Simul]		
Television Port:	[Enabled]		
Television Type:	[NTSC]		
Visit our WebSite http://www.dell.com			
F1	Help	Select	F5/F6 Change Values
ESC	Exit	Item	Enter Select > Sub-Menu
			F9 Setup Defaults
			F10 Save and Exit

 **HINT:** External USB keyboards only function when Windows is running.

 **HINT:** Toll-free numbers are for use within the country for which they are listed.

Viewing Settings

- 1 Turn on (or restart) your computer.
- 2 When the blue Dell logo appears, press immediately.

If you wait too long and the operating system logo appears, continue to wait until you see the Windows desktop. Then shut down your computer and try again.

Contacting Dell

When you need to contact Dell, use the telephone numbers, codes, and electronic addresses provided in the following tables. If you need assistance in determining which codes to use, contact a local or an international operator.

Contact Numbers and Addresses

Country (City) International Access Code Country Code City Code	Department Name or Service Area	Area Codes, Local Numbers, and Toll-Free Numbers
Australia (Sydney) International Access Code: 0011 Country Code: 61 City Code: 2	Home and Small Business..... 1-300-65-55-33 Government and Business toll free: 1-800-633-559 Preferred Accounts Division (PAD)..... toll free: 1-800-060-889 Customer Care toll free: 1-800-819-339 Corporate Sales toll free: 1-800-808-385 Transaction Sales toll free: 1-800-808-312 Fax..... toll free: 1-800-818-341	
Austria (Vienna) International Access Code: 900 Country Code: 43 City Code: 1	Home/Small Business Sales 01 795 567602 Home/Small Business Fax..... 01 795 67605 Home/Small Business Customer Care 01 795 67603 Preferred Accounts/Corporate Customer Care..... 0660 8056 Home/Small Business Technical Support 01 795 67604 Preferred Accounts/Corporate Technical Support 0660 8779 Switchboard 01 491 04 0 Website: http://support.euro.dell.com E-mail: tech_support_germany@dell.com	

Country (City) International Access Code Country Code City Code	Department Name or Service Area	Area Codes, Local Numbers, and Toll-Free Numbers
Belgium (Brussels) International Access Code: 00 Country Code: 32 City Code: 2	Technical Support Customer Care Home/Small Business Sales toll free: 0800 16884 Corporate Sales Fax Switchboard Website: http://support.euro.dell.com E-mail: tech_be@dell.com	02 481 92 88 02 481 91 19 02 481 91 00 02 481 92 99 02 481 91 00
Brazil International Access Code: 0021 Country Code: 55 City Code: 51	Customer Support, Technical Support Sales Website: http://www.dell.com/br	0800 90 3355 0800 90 3366
Brunei Country Code: 673	Customer Technical Support (Penang, Malaysia) Customer Service (Penang, Malaysia) Transaction Sales (Penang, Malaysia)	633 4966 633 4949 633 4955
Canada (North York, Ontario) International Access Code: 011	Automated Order-Status System toll free: 1-800-433-9014 AutoTech (Automated technical support) toll free: 1-800-247-9362 Customer Care (From outside Toronto) toll free: 1-800-387-5759 Customer Care (From within Toronto) 416 758-2400 Customer Technical Support toll free: 1-800-847-4096 Sales (Direct Sales—from outside Toronto) toll free: 1-800-387-5752 Sales (Direct Sales—from within Toronto) 416 758-2200 Sales (Federal government, education, and medical) toll free: 1-800-567-7542 Sales (Major Accounts) toll free: 1-800-387-5755 TechFax toll free: 1-800-950-1329	toll free: 1-800-433-9014 toll free: 1-800-247-9362 toll free: 1-800-387-5759 416 758-2400 toll free: 1-800-847-4096 toll free: 1-800-387-5752 416 758-2200 toll free: 1-800-567-7542 toll free: 1-800-387-5755 toll free: 1-800-950-1329
Chile (Santiago) Country Code: 56 City Code: 2	Sales, Customer Support, and Technical Support toll free: 1230-020-4823	toll free: 1230-020-4823

Country (City) International Access Code Country Code City Code	Department Name or Service Area	Area Codes, Local Numbers, and Toll-Free Numbers
China (Xiamen) Country Code: 86 City Code: 592	Technical Support Customer Experience..... Home and Small Business..... Preferred Accounts Division Large Corporate Accounts	toll free: 800 858 2437 toll free: 800 858 2060 toll free: 800 858 2222 toll free: 800 858 2062 toll free: 800 858 2999
Czech Republic (Prague) International Access Code: 00 Country Code: 420 City Code: 2	Technical Support Customer Care Fax..... TechFax..... Switchboard..... Website: http://support.euro.dell.com E-mail: czech_dell@dell.com	02 22 83 27 27 02 22 83 27 11 02 22 83 27 14 02 22 83 27 28 02 22 83 27 11
Denmark (Horsholm) International Access Code: 009 Country Code: 45	Technical Support Relational Customer Care Home/Small Business Customer Care Switchboard..... Fax Technical Support (Upplands Vasby, Sweden) Fax Switchboard..... Website: http://support.euro.dell.com E-mail: den_support@dell.com	45170182 45170184 32875505 45170100 859005594 45170117
Finland (Helsinki) International Access Code: 990 Country Code: 358 City Code: 9	Technical Support Technical Support Fax Relational Customer Care Home/Small Business Customer Care Fax..... Switchboard..... Website: http://support.euro.dell.com E-mail: fin_support@dell.com	09 253 313 60 09 253 313 81 09 253 313 38 09 693 791 94 09 253 313 99 09 253 313 00

Country (City) International Access Code Country Code City Code	Department Name or Service Area	Area Codes, Local Numbers, and Toll-Free Numbers
France (Paris/Montpellier) International Access Code: 00 Country Code: 33 City Code: (1) (4)	Technical Support Customer Care (Paris) Customer Care (Montpellier) Fax (Montpellier) Switchboard (Paris) Switchboard (Montpellier) Website: http://support.euro.dell.com E-mail: web_fr_tech@dell.com	0803 387 270 01 55 94 75 75 0825 823 833 04 67 06 60 01 01 55 94 71 00 04 67 06 60 00
Germany (Langen) International Access Code: 00 Country Code: 49 City Code: 6103	Technical Support Technical Support Fax Home/Small Business Customer Care Global Segment Customer Care Preferred Accounts Customer Care..... Large Accounts Customer Care Public Accounts Customer Care Switchboard..... Website: http://support.euro.dell.com E-mail: tech_support_germany@dell.com	06103 766-7200 06103 766-9222 0180-5-224400 06103 766-9570 06103 766-9420 06103 766-9560 06103 766-9555 06103 766-7000
Hong Kong International Access Code: 001 Country Code: 852	Technical Support Customer Service (Penang, Malaysia) Transaction Sales Corporate Sales	toll free: 800 96 4107 633 4949 toll free: 800 96 4109 toll free: 800 96 4108
Ireland (Bray) International Access Code: 16 Country Code: 353 City Code: 1	Technical Support Customer Care Sales SalesFax Fax TechFax Switchboard..... Website: http://support.euro.dell.com E-mail: dell_direct_support@dell.com	1-850-543-543 01 204 4026 1-850-235-235 01 286 2020 01 286 6848 01 204 4708 01 286 0500

Country (City) International Access Code Country Code City Code	Department Name or Service Area	Area Codes, Local Numbers, and Toll-Free Numbers
Italy (Milan) International Access Code: 00 Country Code: 39 City Code: 2	Technical Support Customer Care Sales Fax Switchboard Website: http://support.euro.dell.com E-mail: support_italy@dell.com	2 57782.690 2 57782.555 2 57782.411 2 57503530 2 57782.1
Japan (Kawasaki) International Access Code: 001 Country Code: 81 City Code: 44	Technical Support (Dimension™ and Inspiron™) ..toll free: 0120-1982-56 or Customer Care Home and Small Business Group Sales Preferred Accounts Division Sales Large Corporate Accounts Faxbox Service Switchboard Website: http://support.jp.dell.com	0088-25-3355 044 556-4240 044 556-3344 044 556-3433 044 556-3430 03-5972-5840 044 556-4300
Korea (Seoul) International Access Code: 001 Country Code: 82 City Code: 2	Technical Support Sales Customer Service (Seoul, Korea) Customer Service (Penang, Malaysia) Fax Switchboard	toll free: 080-200-3800 toll free: 080-200-3777 2194-6220 604-633-4949 2194-6202 2194-6000
Latin America	Customer Technical Support (Austin, Texas, U.S.A.) Customer Service (Austin, Texas, U.S.A.) Fax (Technical Support and Customer Service) (Austin, Texas, U.S.A.) Sales (Austin, Texas, U.S.A.) SalesFax (Austin, Texas, U.S.A.)	512 728-4093 512 728-3619 512 728-3883 512 728-4397 512 728-4600 728-3772

Country (City) International Access Code Country Code City Code	Department Name or Service Area	Area Codes, Local Numbers, and Toll-Free Numbers
Luxembourg International Access Code: 00 Country Code: 352	Technical Support (Brussels, Belgium) Home/Small Business Sales (Brussels, Belgium) Corporate Sales (Brussels, Belgium) Customer Care (Brussels, Belgium) Fax (Brussels, Belgium) Switchboard (Brussels, Belgium) Website: http://support.euro.dell.com E-mail: tech_be@dell.com 02 481 92 88 toll free: 080016884 02 481 91 00 02 481 91 19 02 481 92 99 02 481 91 00
Macau Country Code: 853	Technical Support Customer Service (Penang, Malaysia) Transaction Sales toll free: 0800 582 633 4949 toll free: 0800 581
Malaysia (Penang) International Access Code: 00 Country Code: 60 City Code: 4	Technical Support Customer Service Transaction Sales Corporate Sales toll free: 1 800 888 298 04 633 4949 toll free: 1 800 888 202 toll free: 1 800 888 213
Mexico (Colonia Granada) International Access Code: 95 Country Code: 52 City Code: 5	Automated Order-Status System (Austin, Texas, U.S.A.) AutoTech (Automated technical support) (Austin, Texas, U.S.A.) Customer Technical Support Sales Customer Service Main 512 728-0685 512 728-0686 525 228-7870 525 228-7811 toll free: 91-800-900-37 toll free: 91-800-904-49 525 228-7878 525 228-7800
Netherlands (Amsterdam) International Access Code: 00 Country Code: 31 City Code: 20	Technical Support Customer Care Home/Small Business Sales Home/Small Business Sales Fax Corporate Sales Corporate Sales Fax Fax Switchboard Website: http://support.euro.dell.com E-mail: tech_nl@dell.com 020 581 8838 020 581 8740 toll free: 0800-0663 020 682 7171 020 581 8818 020 686 8003 020 686 8003 020 581 8818

Country (City) International Access Code Country Code City Code	Department Name or Service Area	Area Codes, Local Numbers, and Toll-Free Numbers
New Zealand International Access Code: 00 Country Code: 64	Home and Small Business..... Government and Business Sales Fax.....	0800 446 255 0800 444 617 0800 441 567 0800 441 566
Norway (Lysaker) International Access Code: 095 Country Code: 47	Technical Support Relational Customer Care Home/Small Business Customer Care Switchboard..... Fax Technical Support (Upplands Vasby, Sweden) Fax Switchboard..... Website: http://support.euro.dell.com E-mail: nor_support@dell.com	671 16882 671 17514 23162298 671 16800 590 05 594 671 16865
Poland (Warsaw) International Access Code: 011 Country Code: 48 City Code: 22	Technical Support Customer Care Sales Fax..... Switchboard..... Website: http://support.euro.dell.com E-mail: pl_support@dell.com	22 60 61 999 22 60 61 999 22 60 61 999 22 60 61 998 22 60 61 999
Singapore (Singapore) International Access Code: 005 Country Code: 65	Technical Support Customer Service (Penang, Malaysia)..... Transaction Sales..... Corporate Sales	toll free: 800 6011 051 04 633 4949 toll free: 800 6011 054 toll free: 800 6011 053
South Africa (Johannesburg) International Access Code: 09/091 Country Code: 27 City Code: 11	Technical Support Customer Care Sales Fax..... Switchboard..... Website: http://support.euro.dell.com E-mail: dell_za_support@dell.com	011 709 7710 011 709 7710 011 706 7700 011 709 0495 011 709 7700
Southeast Asian and Pacific Countries	Customer Technical Support, Customer Service, and Sales (Penang, Malaysia).....	60 4 633 4810

Country (City) International Access Code Country Code City Code	Department Name or Service Area	Area Codes, Local Numbers, and Toll-Free Numbers
Spain (Madrid) International Access Code: 07 Country Code: 34 City Code: 91	Technical Support Corporate Customer Care Home/Small Business Customer Care Corporate Sales Home/Small Business Sales Switchboard	902 100 130 902 118 546 902 118 540 902 100 185 902 118 541 91 722 92 00
	Website: http://support.euro.dell.com E-mail: es_support@dell.com	
Sweden (Upplands Vasby) International Access Code: 009 Country Code: 46 City Code: 8	Technical Support Relational Customer Care Home/Small Business Customer Care Fax Technical Support Sales	08 590 05 199 08 590 05 642 08 587 70 527 08 590 05 594 08 590 05 185
	Website: http://support.euro.dell.com E-mail: swe_support@dell.com	
Switzerland (Geneva) International Access Code: 00 Country Code: 41 City Code: 22	Technical Support Customer Care Fax Switchboard	0844 811 411 0848 802 802 022 799 01 90 022 799 01 01
	Website: http://support.euro.dell.com E-mail: swisstech@dell.com	
Taiwan International Access Code: 002 Country Code: 886	Technical Support Technical Support (servers) Transaction Sales Corporate Sales	toll free: 0080 60 1255 toll free: 0080 60 1256 toll free: 0080 651 228/0800 33 556 toll free: 0080 651 227/0800 33 555
Thailand International Access Code: 001 Country Code: 66	Technical Support Customer Support (Penang, Malaysia) Sales	toll free: 0880 060 07 633 4949 toll free: 0880 060 09

**Country (City)
International Access Code
Country Code
City Code**

U.K. (Bracknell)
International Access Code: 010
Country Code: 44
City Code: 1344

**Department Name or
Service Area**

**Area Codes,
Local Numbers, and
Toll-Free Numbers**

Technical Support	0870 908 0800
Global Accounts Customer Care.....	01344 723186
Corporate Customer Care	01344 723185
Preferred Accounts (555-5000 employees) Customer Care	01344 723196
Central Government Customer Care	01344 723193
Local Government Customer Care	01344 723194
Home/Small Business Sales	0870 907 4000
Corporate/Public Sector Sales	01344 860456
AutoFax.....	0870 908 0510

Website: <http://support.euro.dell.com>

E-mail: dell_direct_support@dell.com

**Country (City)
International Access Code
Country Code
City Code**

U.S.A. (Austin, Texas)
International Access Code: 011
Country Code: 1

**Department Name or
Service Area**

**Area Codes,
Local Numbers, and
Toll-Free Numbers**

Automated Order-Status System toll free: 1-800-433-9014
 AutoTech (Automated technical support) toll free: 1-800-247-9362
 Dell Home and Small Business Group:
 Customer Technical Support
 (Return Material Authorization Numbers) toll free: 1-800-624-9896
 Customer Technical Support
 (Home sales purchased via
<http://www.dell.com>) toll free: 1-877-576-3355
 Customer Service
 (Credit Return Authorization Numbers) toll free: 1-800-624-9897
National Accounts (systems purchased by established Dell national
 accounts [have your account number handy], medical institutions, or
 value-added resellers [VARs]):
 Customer Service and Technical Support
 (Return Material Authorization Numbers) toll free: 1-800-822-8965
Public Americas International (systems purchased by governmental agen-
 cies [local, state, or federal] or educational institutions):
 Customer Service and Technical Support
 (Return Material Authorization Numbers) toll free: 1-800-234-1490
 Dell Sales toll free: 1-800-289-3355
 toll free: 1-800-879-3355
 Spare Parts Sales toll free: 1-800-357-3355
 DellWare™ toll free: 1-800-753-7201
 Fee-Based Technical Support toll free: 1-800-433-9005
 Sales (Catalogs) toll free: 1-800-426-5150
 Fax toll free: 1-800-727-8320
 TechFax toll free: 1-800-950-1329
 Dell Services for the Deaf, Hard-of-Hearing,
 or Speech-Impaired toll free: 1-877-DELLTY (1-877-335-5889)
 Switchboard 512 338-4400
 Dellnet Technical Support 1-877-Dellnet

Returning Items for Warranty Repair or Credit

Prepare all items being returned, whether for repair or credit, as follows:

- 1 Call Dell to obtain an authorization number, and write it clearly and prominently on the outside of the box.
- 2 Include a copy of the invoice and a letter describing the reason for the return.
- 3 Include any accessories that belong with the item(s) being returned (power cables, CDs, guides, and so on) if the return is for credit.
- 4 Pack the equipment to be returned in the original (or equivalent) packing materials.

You are responsible for paying shipping expenses. You are also responsible for insuring any product returned, and you assume the risk of loss during shipment to Dell. Collect-on-delivery packages are not accepted.

Returns that are missing any of the preceding requirements will be refused at our receiving dock and returned to you.

Regulatory Information

Electromagnetic Interference (EMI) is any signal or emission, radiated in free space or conducted along power or signal leads, that endangers the functioning of a radio navigation or other safety service or seriously degrades, obstructs, or repeatedly interrupts a licensed radio communications service. Your Dell computer is designed to comply with applicable regulations regarding EMI. Changes or modifications not expressly approved by Dell could void the user's authority to operate the equipment.

Additional regulatory information regarding your computer can be found in the *Tell Me How* help file. To open the file, click the **Start** button on the Windows desktop, point to **Dell Documents**, and then click **Tell Me How**.



Battery Disposal

Your computer uses a lithium-ion battery and a nickel-metal hydride (NiMH) coin-cell battery. For instructions about replacing the lithium-ion battery in your computer, see page 54.

The coin-cell battery is a long-life battery, and it is very possible that you will never need to replace it. However, should you need to replace it, the procedure must be performed by an authorized service technician.

Do not dispose of the battery along with household waste. Contact your local waste disposal agency for the address of the nearest battery deposit site.

NOM Information (Mexico Only)

The following information is provided on the device(s) described in this document in compliance with the requirements of the official Mexican standards (NOM):

Exporter:	Dell Computer Corporation One Dell Way Round Rock, TX 78682
Importer:	Dell Computer de México, S.A. de C.V. Rio Lerma No. 302 - 4° Piso Col. Cuauhtemoc 16500 México, D.F.
Ship to:	Dell Computer de México, S.A. de C.V. al Cuidado de Kuehne & Nagel de México S. de R.I. Avenida Soles No. 55 Col. Peñon de los Baños 15520 México, D.F.
Supply voltage:	100–240 VAC
Frequency:	50–60 Hz
System input voltage:	20 VDC, 3.5 A
Current consumption:	1.5 A

Información para NOM (únicamente para México)

La información siguiente se proporciona en el dispositivo o en los dispositivos descritos en este documento, en cumplimiento con los requisitos de la Norma Oficial Mexicana (NOM):

Exportador:	Dell Computer Corporation One Dell Way Round Rock, TX 78682
Importador:	Dell Computer de México, S.A. de C.V. Rio Lerma No. 302 - 4° Piso Col. Cuauhtemoc 16500 México, D.F.
Embarcar a:	Dell Computer de México, S.A. de C.V. al Cuidado de Kuehne & Nagel de México S. de R.I. Avenida Soles No. 55 Col. Peñon de los Baños 15520 México, D.F.
Tensión alimentación:	100–240 VAC
Frecuencia:	50–60 Hz
Voltaje de entrada del sistema:	20 VDC, 3.5 A
Consumo de corriente:	1.5 A

Warranty and Return Policy Information

Dell Computer Corporation (“Dell”) manufactures its hardware products from parts and components that are new or equivalent to new in accordance with industry-standard practices. For information about the Dell warranty for your computer, see the *Tell Me How* help file. To open the file, click the **Start** button on the Windows desktop, point to **Dell Documents**, and then click **Tell Me How**.

Index

A

- APR
 - buttons and indicators, 61
 - connecting external devices, 58
 - connecting to a network, 22
 - connectors, 59
 - docking the computer, 56
 - undocking, 58
- audio. *See* sound

B

- battery installation, 54
- BIOS, 74

C

- CD drive
 - fixing problems, 37
- CD-RW drive
 - fixing problems, 38
- characters
 - unexpected, 36
- computer
 - crashes, 40
 - error messages, 30
 - specifications, 68
 - turning off, 20

- contact numbers, 76
- crashes, 40

D

- damaged computer
 - testing, 43
- Dellnet, 16
- display
 - fixing problems, 30
- drivers
 - reinstalling, 44
- drives
 - fixing problems, 36
- DVD drive
 - fixing problems, 38

E

- e-mail
 - accessing, 16
 - fixing problems, 42
 - sending and receiving, 16
- error messages
 - start-up, 30
 - Windows, 39
- external keyboard
 - fixing problems, 36

F

- finding solutions, 27
- floppy drive
 - fixing problems, 36

H

- hard drive
 - fixing problems, 38
 - preventing damage, 65
 - preventing data loss, 65
 - replacing, 64
 - returning to Dell, 66
 - troubleshooting, 38
- hibernate file
 - create, 49
 - delete, 48
 - enable support, 49

I

- Internet
 - connecting to, 16
 - fixing problems, 41

K

- keyboard
 - fixing problems, 36

unexpected characters, 36

M

memory

- 192-MB modules, 62
- adding, 62
- removing, 63

messages

- start-up, 30
- Windows, 39

modem

- fixing problems, 34

modular bay

- swapping devices (computer on), 53

N

network

- fixing problems, 39
- setting up the APR, 22

P

password

- changing for Dellnet, 16

PC Cards

- installation, 56
- removal, 56

port replicator

- buttons and indicators, 61
- connecting external devices, 58
- connecting to a network, 22
- connectors, 59

- docking the computer, 56
- undocking, 58

power

- fixing problems, 29
- turning off, 20

printer

- connecting, 18
- fixing problems, 33
- reinstalling driver, 20
- setting up, 18
- troubleshooting, 33

programs

- crashes, 40
- fixing problems, 40
- not responding, 40

R

RAM. *See* memory

reinstalling drivers and utilities, 44

resetting Dellnet account, 17

returns, 88

S

safety instructions, 5

ScanDisk, 38

settings

- system setup program, 74

shutdown, 20

software

- fixing problems, 40

sound

- adjusting volume, 31
- fixing problems, 31

speaker

- adjusting volume, 31
- fixing problems, 31

specifications, 68

system setup program, 74

T

technical assistance

- telephone numbers and addresses, 76
- warranty repair or credit, 85

touch pad

- fixing problems, 36

troubleshooting, 27

- blank display, 30
- blue screen, 41
- cannot play a DVD movie, 38
- cannot save to floppy disk, 36
- CD problems, 37
- CD-RW drive stops writing, 38
- display difficult to read, 30
- dropped or damaged computer, 43
- e-mail problems, 42
- external keyboard problems, 36
- external speaker problems, 32
- integrated speaker problems, 31
- Internet connection problems, 41
- modem problems, 34
- network problems, 39

- parallel printer problems, 33
- power problems, 29
- program crash, 40
- program stopped
 - responding, 40
- scanner problems, 35
- start-up error messages, 30
- touch pad problems, 36
- unexpected characters, 36
- USB printer problems, 33
- wet computer, 42
- Windows error messages, 39

- turning off the computer, 20

V

- video
 - fixing problems, 30

W

- warranty, 88
- wet computer, 42

- Windows 2000
 - error messages, 39
 - reinstalling, 46
 - shutdown, 21

- Windows 98
 - error messages, 39
 - reinstalling, 45
 - shutdown, 21

- Windows Me
 - error messages, 39
 - reinstalling, 45
 - shutdown, 21

